

54

APR 23 1960

SERVICE
MANUAL 2325



marantz

model 2325

Stereophonic Receiver

TABLE OF CONTENTS

| SECTION | PAGE |
|--|----------|
| Introduction | 1 |
| Service Notes | 1 |
| AM Tuner | 1 |
| FM Tuner | 2 |
| Phono Amplifier | 5 |
| Buffer, Tone and Filter Amplifiers | 5 |
| Power Amplifier | 5 |
| Power Protection Circuit | 6 |
| Speaker Protector Relay Circuit | 6 |
| Dolby Unit | 6 |
| 400Hz Tone | 7 |
| Dolby Switch | 7 |
| Record Level (L) and (R) Knobs | 7 |
| Play Cal. (L) and (R) Knobs | 8 |
| Dolby FM Preset Level Controls | 8 |
| 400Hz Tone Switch | 8 |
| Suggestions for Troubleshooting Power Amplifier | 8 |
| Test Equipment Required for Servicing | 9 |
| AM Alignment Procedures | 9 |
| FM Alignment Procedures | 10 |
| Audio Adjustment | 11 |
| Dolby Alignment Procedure | 11 |
| Dolby FM Preset Level Control Alignment Procedures | 12 |
| Description of Dolby Processing Chart | 13 |
| Parts List | 26~41 |
| Technical Specifications | 42~43 |
| Servicing Informations for European Model | 44~46,49 |

LIST OF ILLUSTRATIONS

| FIGURE | PAGE |
|---|-------|
| 1. Block Diagram of the HA1156 | 4 |
| 2. Dial Stringing | 8 |
| 3. Front Panel Adjustments and Component Locations | 15 |
| 4. Main Chassis Component Locations (Top View) | 15 |
| 5. Rear Panel Adjustments and Component Locations | 16 |
| 6. Main Chassis Component Locations (Bottom View)..... | 16 |
| 7. FM Front End Assembly P100 Component Locations | 17 |
| 8. AM Tuner Assembly P150 Component Locations | 17 |
| 9. FM IF Amplifier Assembly P200 Component Locations | 17 |
| 10. MPX Stereo Decoding Amplifier Assembly P300 Component Locations | 18 |
| 11. Phono Amplifier Assembly P400 Component Locations | 18 |
| 12. Dolby Unit Assembly P600 Component Locations | 19 |
| 13. Power Amplifier Assembly P700 Component Locations | 19 |
| 14. Power Supply and Protection Relay Circuit Assembly P800 Component Locations | 20 |
| 15. FM Cal. and De-Emphasis Assembly PC01 Component Locations | 20 |
| 16. Pre and Tone Amplifier Assembly PE01 Component Locations | 20 |
| 17. Buffer Amplifier Assembly PH01 Component Locations | 21 |
| 18. Dolby, Tone and Meter Assembly PL01 Component Locations | 21 |
| 19. Dolby Tone, Tape Mon. Assembly PS01 Component Locations | 21 |
| 20. Tape Monitor Assembly PT01 Component Locations | 21 |
| 21. Multipath, Hi Blend, FM Muting, Low Filter, Hi Filter, Loudness, Main Speaker and Remote Speaker Assembly PU01 Component Locations | 21 |
| 22. Antenna Terminal Assembly PV01 Component Locations | 22 |
| 23. Function Lamp Assembly PY01 Component Locations | 22 |
| 24. Dial Lamp Assembly PZ01 Component Locations | 22 |
| 25. Exploded Mechanical Diagram | 24~25 |
| 26. Rear Panel Adjustments and Component Locations | 45 |
| 27. Main Chassis Component Locations (Top View) | 45 |
| 28. Voltage Conversion Chart | 46 |
| 29. Schematic Diagram for U.S.A. Model | 48 |
| 30. Schematic Diagram for European Model | 49 |

| TABLE | PAGE |
|--|------|
| 1. Test Equipment Required for Servicing | 9 |
| 2. Dolby Processing Chart | 14 |

INTRODUCTION

This service manual was prepared for use by Authorized Warranty Stations and contains service information for the Marantz Model 2325 Stereophonic Receiver.

Servicing information and voltage data included in this manual are intended for use by the knowledgeable and experienced technician only. All instructions should be read carefully. No attempt should be made to proceed without a good understanding of the operation of the receiver.

The parts list furnishes information by which replacement part may be ordered from the Marantz Company. A brief description is included for parts which can be usually be obtained through local suppliers.

1. SERVICE NOTES

As can be seen from the circuit diagram, the chassis of the Model 2325 consists of the following units. Each unit mounted on a printed circuit board is drawn within bold dotted-line block on the circuit diagram.

- | | |
|--|----------------------------|
| 1. FM Front End | Mounted on P.W. Board P100 |
| 2. AM Tuner Unit | Mounted on P.W. Board P150 |
| 3. FM IF Amplifier | Mounted on P.W. Board P200 |
| 4. MPX Stereo Decoding Amplifier | Mounted on P.W. Board P300 |
| 5. Phono Amplifier | Mounted on P.W. Board P400 |
| 6. Dolby Unit | Mounted on P.W. Board P600 |
| 7. Power Amplifier | Mounted on P.W. Board P700 |
| 8. Power Supply and Protection Relay Circuit | Mounted on P.W. Board P800 |
| 9. FM Cal. | Mounted on P.W. Board PC01 |
| 10. Pre and Tone Amplifier | Mounted on P.W. Board PE01 |
| 11. Buffer Amplifier | Mounted on P.W. Board PH01 |
| 12. 400Hz Tone | Mounted on P.W. Board PL01 |
| 13. 400Hz Tone, Tape 1 and 2 | |
| Tape Monitor Switch | Mounted on P.W. Board PS01 |
| 14. Tape Monitor Assembly | Mounted on P.W. Board PT01 |
| 15. Multipath, Hi Blend, FM Muting, Low Filter, Hi Filter, Loudness, Main Speaker and Remote Speaker | Mounted on P.W. Board PU01 |
| 16. Function Lamp | Mounted on P.W. Board PY01 |
| 17. Dial Lamp | Mounted on P.W. Board PZ01 |

2. AM TUNER

The AM Tuner section in the 2325 consists of one IC, including an RF amplifier, local oscillator, mixer, IF amplifier, and detector, and three transistors, one of which forms a signal strength indication amplifier and the other two form detected audio signal amplifier.

All components except the tuning capacitor and ferrite bar antenna are mounted on the printed circuit board P150.

The AM signal induced in the ferrite bar antenna is fed to the RF amplifier input (Pin ②) and amplified to the level required for overcoming conversion noises, thus giving good S/N performance. The tuned circuit inserted in each of the output and input circuits of the RF amplifier assures very high image and spurious rejection performance.

Thus the amplified and selected AM signal is then applied to one Mixer input (Pin ①). While the local oscillator voltage is injected to the other Mixer input (Pin ⑥) through a capacitor C157. Then both AM signal and local oscillator output voltage are mixed and converted into 455kHz intermediate frequency. The resulting IF signal is applied to the IF transformer L153 consisting of one ceramic filter and two tuned circuits.

The output of L153 is led to the IF amplifier input (Pin ⑨) through a coupling capacitor C162 and amplified to the sufficient level to drive the detector. The detected audio signal derived from pin ⑦ is filtered and amplified, and the final audio output is obtained from the collector of H153 and applied to the TAPE MONITOR OUT jacks through the function switch.

The DC component of the detected IF signal is used as an AGC voltage to control emitter current of RF amplifier through the AGC amplifier incorporated in the IC. A part of the DC component is also led to the signal strength indication amplifier H154. The output appearing at the collector of H154 is level adjusted by R178, indicated on the signal strength meter M002.

2.1 Suggestions for Troubleshooting AM Tuner

Check for broken AM bar antenna, next try to tune stations by rotating the fly-wheel tuning knob slowly and observe the AM signal strength meter whether it deflects or not. If the signal strength meter gives a deflection at several received frequencies, no failure may exist in the stages at least preceding the detector circuits. Next, connect an oscilloscope to the test point ⑥ or J161 and check for audio signals with the tuning meter deflected. If the signal strength meter does not deflect, check the local oscillator circuit. Normal local oscillator output voltage at the hot end of the oscillator tuning capacitor is about 1.5 or 3 volts, varying with the tuning capacitor position. When measuring the local oscillator output voltage use an RF VTVM, no circuit tester gives correct indication. If the local oscillator output voltage is normal, check all voltage distribution in the AM circuits by using a DC VTVM and compare the measured values with those given in the schematic diagram.

3. FM TUNER

The FM Tuner section in the Model 2325 consists of four functional blocks: FM Front End, IF Amplifier & Detector, Muting Control and MPX Stereo Decoding Circuit.

An FM signal induced by the FM antenna is led to FM antenna coil L101 through the balun coil. The signal is then applied to the FET RF amplifier which in turn feeds its output to the next FET Mixer H102 through the triple tuned high selective circuit. The FET Mixer converts its input signal into 10.7MHz IF signal and amplifies it at the same time. The H103 is a local oscillator, the output of which is injected into the source of the FET Mixer, the injection voltage being about 700mV. The 10.7MHz front end output is led to the next IF amplifier unit through the coaxial cable.

The IF amplifier unit consists of seven IF amplifier stages and one AGC amplifier stage. Eight pieces of ceramic filter are also used to obtain high selectivity, and four symmetrical diode limiter stages are also employed for the best limiting characteristics, improved capture ratio and good AM suppression.

A part of the FM Front End output is fed to and rectified by the AGC amplifier H209, and the rectified output is fed back to the gate of the FET RF amplifier to decrease the gain with increase of the signal strength.

The signals required for multipath indication are obtained from the five IF amplifier stages through the coupling capacitors C252, C211, C214, C223 and C228, respectively, and are rectified by five pairs of full-wave diode circuit. Thus these AM components of the FM signal are approximately mixed and amplified by the transistors HU01 and HU02 and the output is again rectified to obtain DC current required for actuating the Multipath Indication meter.

The IF signal sufficiently amplified through each IF amplifier stage is finally led to the Detector Amplifier H208. The detected audio output is led to the buffer amplifier H210 and its buffered output is led to: (a) the noise amplifier H310 through the resistor R378 and capacitor C333, (b) the QUADRADIAL OUTPUT Jack on the rear panel through the resistor R379, (c) the MPX stereo decoding IC (H321) through R301 and H301.

The DC current caused at the third windings of the discriminator transformer is directly led to the FM center tuning meter.

3.1 Audio Muting and Stereo mode auto-selecting circuit

The muting circuit consisting of all solid-state electrical switching is incorporated in the Model 2325. Three inputs control the muting function. The first is related to signal strength, the second to the noise condition at the detector, and the third is derived from the DC component of the detector output. These inputs are properly matrixed and gated to provide muting free from noise and transients.

The first input of DC voltage obtained by rectifying a part of the IF output signal from the H205 and H206 is fed to the base of H308 and turns it on, if the IF output is greater than a predetermined level (muting threshold level). When the H308 is turned on, the H309 is turned off, allowing the emitter-collector resistance to be increased and the collector voltage to be raised to about 9V. The raised collector voltage increases the gate bias voltage and turns the switching FET H301 on, decreasing the source-drain resistance to near zero ohm and allowing the audio signal applied to the source to flow to the decoding IC pin ② through the source-drain path.

When the input signal is lower than the predetermined level, the DC output obtained is small and can not turn on the H308, thus H308 keeps its off state. This turns H309 on, decreasing the collector voltage and turning H301 off. Thus no audio signals can pass through the FET. This is the fundamental principle of the muting operation but for more elaborate muting operation, the second and the third inputs are necessary.

The second input is used to protect the muting operation and MPX stereo beacon lamps from misoperation due to undesirable noises. The high frequency noises included in the detected audio signals are separated by a small capacitor C333 and are amplified by the noise amplifier transistor H310. Its output is rectified by the two diodes. The rectified DC output is proportional to the noise components in the audio signals.

When there are excessive noises in the audio signals such as obtained with a station incorrectly turned in, the rectified DC output turns the transistor H311 on, decreasing the emitter-collector resistance to zero. This means the collector of H309 is grounded, therefore the H301 is turned off and any audio signals having excessive, high-frequency noises can not go through the FET's source-drain path.

The transistor H317, also, turns off when the transistor H309 or H311 turns on, and turns on the transistor H303 connected to pin ⑧ on the MPX decoding IC. Pin ⑧ is therefore grounded equivalently to set the IC in the monaural mode of operation. This prevents misoperation due to undesirable noises when the FM tuner is out of tuning.

The third input is obtained from the FM discriminator circuit. The DC output, so called "S" curve, is applied to the gate of H312 through the resistor R281 and voltage divider network (R361, R362). The DC output is zero with a station correctly tuned in, but will vary from negative to positive value, or vice versa, when the tuning point is deviated toward either higher or lower frequency from the correct tuning point.

When the DC output is increased to greater level than the predetermined one, the increased source potential of H312 turns the transistor H315 on. (This means the collector of H309 is grounded, H301 turns off, H317 turns off, and H303 turns on.) This grounds pin ⑧ at the MPX stereo decoding IC, therefore the decoder is set in the monaural mode of operation and the stereo indicator lamp turns off. When the DC output is increased to the predetermined negative level, the decreased source potential turns the H313 off, which turns the H314 on. (This means the collector of H309 is grounded.) The subsequent changes are exactly the same as that just described above.

Thus when the tuning is shifted or deviated to certain frequencies at which undesirable noisy side-audio signals are produced, both muting and monaural/stereo switching transistors H303 are automatically operated and open the circuits.

With the station correctly tuned in, the bias current of the FET H312 is adjusted so that both transistor H314 and H315 are not turned on, giving no effect on the transistor H309.

3.2 MPX Stereo Decoding Circuit

The stereo composite signal from the buffer amplifier undergoes phase compensation by R301 and C201, is led through the muting switching FET H301 to the input terminal pin ② of the MPX stereo decoding IC H321 on PLL (Phase Locked Loop) basis, and is decoded into the left and right stereo signals, which become available at pins ④ and ⑤, respectively. These decoded left and right stereo audio signals are introduced through the low pass filter consisting of L301 to L304 and C311 to C320 for elimination of undesirable residual switching signal and through the de-emphasis network consisting of R325, R326, C321 and C322 to the npn-pnp direct coupled audio amplifier, where the signals are amplified to a required level for the output from J311 and J313. From these jacks, the audio signals are led through the function switch to the TAPE MONITOR OUT jacks. Figure 1 presents an internal block diagram showing the functions of the PLL basis MPX stereo decoding IC HA1156. The input stereo composite signal, amplified by the audio amplifier, is delivered to the phase detectors PD-1 and PD-2. A part of the stereo composite signal is also delivered to the stereo decoder section. The VCO (Voltage Control Oscillator) produces a free run oscillation in the neighborhood of 76kHz with the time constant determined by the capacitor C305 and resistors R311 and R312 set on the outside of pin ⑭. The VCO output has its frequency divided into 19kHz through the two frequency divider stages (DIV-1, DIV-2), and is reversed to the phase detector PD-1, which contains two input terminals designed to produce an output in proportion to the product of the two input signals. The signal led to one PD-1 input is a 19kHz square wave formed through frequency division of the 76kHz VCO output signal by the two frequency divider stages DIV-1 and DIV-2, and the 19kHz pilot signal included in the stereo composite signal as a reference signal is led to the other PD-1 input. Therefore, the output of the PD-1 which has passed through the low pass filter LPF-1 provides DC output voltage in proportion to the phase variance between the two inputs. This DC output voltage is amplified by the DC amplifier, and is supplied to the 76kHz VCO as a control voltage. This means that the output frequency and phase of the VCO have been phaselocked to the input pilot signal. The 38kHz sub-carrier reproduced by the PLL, as stated above, is delivered through the stereo switch to the stereo decoder section as switching signal, thus driving the decoder stage. One PD-2 input is given the 19kHz resulting from the frequency division completed by the DIV-1 and DIV-3, whereas the other input gets the 19kHz output contained in the composite signal, and the output is provided with a DC output in proportion to the amplitude of the pilot signal.

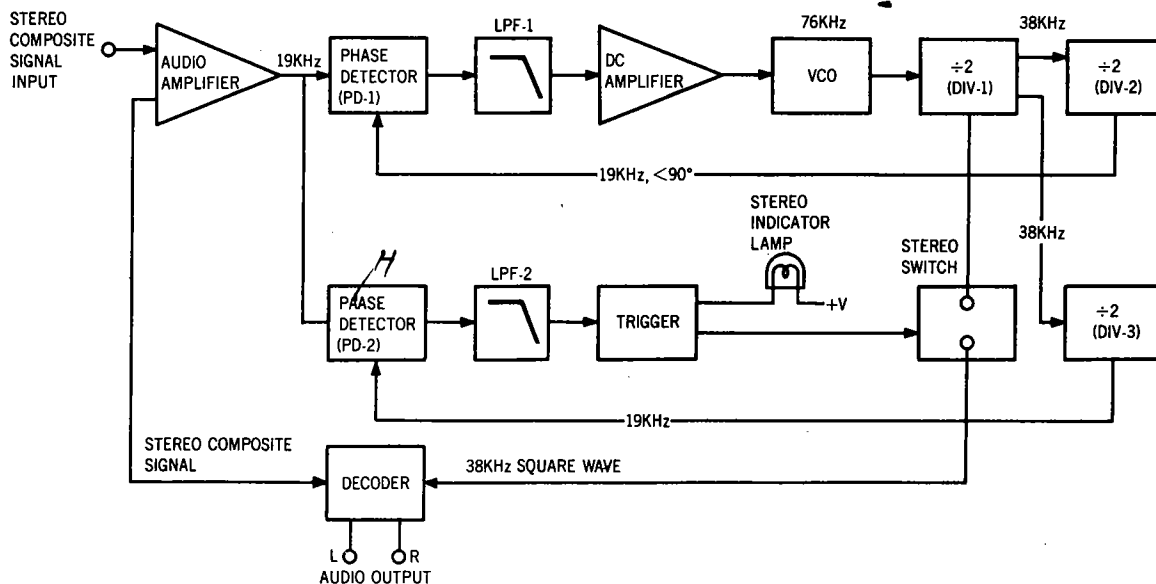

Figure 1. Block Diagram of the HA1156

This DC output is furnished through LPF-2 to the trigger amplifier which drives the stereo indicator lamp and stereo switch. Therefore, insufficient supply of the pilot signal results in failure to light the stereo indicator and to turn on the stereo switch located in the path of the 38kHz switching signal, thereby avoiding a wrong stereo operation.

H303 fitted on the outside of pin ⑧ is a switching transistor for automatic monaural-stereo switchover. When the intensity of an incoming signal from an FM station is weaker than a predetermined level, this H303 is turned on and pin ⑧ is grounded, thereby developing a condition for monaural reception. For a forced monaural operation, switch the MODE switch to "MONO", and H303 comes into the "On" state with the positive bias voltage applied to the base, and pin ⑧ is grounded, thereby establishing monaural operation. The transistor H302 connected externally to pin ⑭ is intended to stop the 76kHz oscillation of the VCO which interferes an AM signal during the reception of an AM station. When the function switch is set to "AM" position, a positive bias is charged on the base of H302, H302 is turned on, and pin ⑭ is grounded. Thus, the oscillation of the VCO is stopped, ending the interference with AM reception.

3.3 Suggestion for Troubleshooting FM Tuner

3.3.1 Symptom: No FM Reception

First turn the POWER switch on and try to tune FM stations. Rotate the fly-wheel tuning knob slowly and observe the FM signal strength meter. If the signal strength meter deflects at several frequencies received, the tuner circuits preceding the discriminator circuit may have no failure. When no reading is obtained in the meter, check the FM local oscillator circuit, using an RF VTVM. The normal local oscillator voltage is one or two volts (rms) at the tuning capacitor, depending on the tuning capacitor position. If the local oscillator voltage is normal, then check all voltage distribution in the FM Front End and IF amplifier unit and compare them with those shown in the circuit diagram. When the signal strength meter deflects but no sound is obtained, check the audio circuit, using a high sensitive oscilloscope.

3.3.2 Symptom: No Stereo Separation

First check that the "MODE" switch is in normal 2 CH position. Connect an FM RF signal generator output modulated by a stereo modulator to the rear FM antenna terminals, and check whether the stereo beacon is turned on or not. If not turned on, check for 19kHz VCO output signal (J310), using an oscilloscope and frequency counter.

4. PHONO AMPLIFIER

Program source signals from the PHONO jacks on the rear panel are fed to the input circuit of the Phono Amplifier through the selector switch, and the output of the Phono Amplifier is led to another section of the selector switch. This amplifier provides a gain of 40dB.

5. BUFFER, TONE AND FILTER AMPLIFIERS

After passing through the FUNCTION switch (S001-2R, -4R) or TAPE MONITOR switch, all signals are converted to low output impedance by the buffer amplifier. The signals, then, are passed through the dolby circuit, MODE switch and HI-BLEND switches and BALANCE and VOLUME controls.

Signals properly attenuated by the VOLUME control are led to the tone amplifier and are subjected to tone control by the BASS, MID and TREBLE controls, and high- and low-cut filter amplifier circuits.

Thus controlled audio signals are then led to the PRE OUT jacks on the rear panel.

6. POWER AMPLIFIER

The signal from the tone filter amplifier is applied to the differential amplifier (base of H701)

through the coupling capacitor C701. The differential amplifier provides very high input impedance, and its collector output (H702) is led to the base of H705 which in turn feeds its output to the next stages: H706 through the network of R721, C710 and R728, and H707 through the network of R721, C711 and R729. The outputs of H706 and H707 are led to the H708 and H709, respectively. H001, H002, H003 and H004 are power transistors used in complementary symmetry configuration and mounted on the heat sink.

To maintain overall amplifier stability and linearity, a degenerative feed back is utilized throughout the amplifier. This feedback is also necessary to reduce distortion to within a specified limit. The RC network of R728 and C710 conditions the feedback signal for the audio signals. R729 and C711 also form a feed back loop provided to obtain a stable zero DC offset voltage at the speaker output terminals. The R713 is a trimming resistor to adjust the DC offset voltage.

A dynamic bias is applied to the bases of driver transistors H708 and H709. This dynamic bias circuit comprises H714, H715 and R740. This provides a variable base bias for driver transistors that automatically maintains the proper base voltage to temperature change. The temperature sensitive biasing components of the dynamic circuit are thermally coupled through the heat sink with the power amplifier transistors.

7. POWER PROTECTION CIRCUIT

A protection circuit for the amplifier is provided by sensing resistor networks and two switching transistors. When the output transistors are over-driven, the current increase through the power output transistor causes increase of the current flowing through R746. This increased voltage potential is applied to the base of H710 through the resistor R732 and turns H712 on. This means that the base of H708 is by-passed through the emitter-collector path of H712 to the ground, since the emitter of H712 is connected through R730 to the base of H708. Thus, the input signal to H708 is restricted to the value which maintains the operation of power transistor within the safety area. A resistor network of R736, R738 and H720 also works as a sensing network. If the center voltage (collector voltage of the power transistors) is excessively increased to a positive value by some troubles, the voltage applied to the base of H710 turns the H712 on, making bypass circuit to protect the power transistors. For the other half cycle of the drive signal, the same operating principle is applied as described above.

8. SPEAKER PROTECTOR RELAY CIRCUIT

The speaker protection circuit consisting of H805, H806, H807, and associated parts protects the speaker system against any loud "pop" sound developed. This circuit is so designed that no sound is heard for the first three or five seconds after the power switch is turned on by the time constant circuit consisting of C813 and R816. This circuit also protects the speaker system against some troubles due to DC unbalance between the speaker system terminals by instantly operating the relay and cutting off the speaker system from the circuit. If the DC unbalance voltage (positive) is developed between speaker terminals by possible defects such as broken power transistor, short-circuits, or broken potentiometer R713, as the base of H808 is connected to the speaker terminal, the transistor H805 is turned on by the offset voltage developed. This turns the transistors H806 and H807 off, thus cutting off the relay and disconnecting the speaker from the output circuit. If a negative offset voltage is developed, this voltage directly turns the H806 and H807 off, which disconnect the speaker from the circuit and protected.

The circuit also protects the speaker system from possible damage if the amplifier is over-driven by very low frequency such as 7 or lower cycles per second.

9. DOLBY UNIT

The Dolby unit built in the Model 2325, which is a switchable processor, is inserted in each of both R and L channels. The attached "DOLBY PROCESSING CHART" will facilitate you to well understand the operation of the Dolby circuit.

An input signal coming to J601 is amplified by H601, and its output signal is led to the filter which cuts off the tape bias. The signal passed through the filter is further amplified and comes to the mixing circuit of the resistors R623 and R625 and to the phase inverting circuit of H607 and H609. The output signal is fed out of J607.

In the recording mode of operation, the signal is fed out of J605 preceding the mixing circuit and is led to J611. The signal is then discriminated in the frequency and level by the dynamic filter consisting of H611, H613, H615 and H617, and is fed back to the mixing circuit.

In the playback mode of operation, a part of the output signal (at J607) is led to J611 and discriminated in the frequency and level by the dynamic filter consisting of H611, H613, H615 and H617 and fed back to the mixing circuit.

10. 400Hz TONE

The 400Hz tone signal which is a 580mV, 400Hz sine wave is available at the TAPE MONITOR OUT terminal at any position of the DOLBY switch (with the exception of the RECORD II position) and SELECTOR switch

The output signal of the 400Hz oscillator consisting of HL01 and HL02 is delivered through the emitter follower HL03 to JL02 and JL03. The output levels at JL02 and JL03 are adjusted to 580mV and approximately 50mV, respectively.

The signal fed from the Dolby Unit P.W. Board (P600) comes to JL04 and is rectified through HL06. The rectified output at JL06 is led to the meter M002.

11. DOLBY SWITCH

This switch sets the Dolby noise-reduction circuit for record or playback and also switches the meter from the AM or FM SIGNAL STRENGTH mode to the DOLBY CAL LEVEL mode, or vice-versa. With the DOLBY switch placed in "OFF" position, the meter will be used as a SIGNAL-STRENGTH meter; in all other positions as a DOLBY CAL LEVEL meter.

11.1 DOLBY FM

This position is used to listen to Dolbyized FM broadcasts. The Dolby FM level has been pre-adjusted at the factory.

11.2 PLAY

This position is used to play back a Dolbyized source (except ~~FM~~).

11.3 OFF

With this position, the Dolby circuit is by-passed and the input signals are directly fed to both TAPE MONITOR OUT jacks and amplifiers.

11.4 RECORD I

For making a Dolbyized recording from an in-coming "flat" (non-Dolbyized) signal. When the MONITOR switch is in the SOURCE (out) position, the "flat" signal will be heard. When the MONITOR switch is in the TAPE (in) position, the Dolbyized signal from the tape will be heard.

11.5 RECORD II

For making a "flat" (non-Dolbyized) recording from an in-coming Dolbyized signal. Regardless of the position of the MONITOR switch, a "flat" signal will be heard.

12. RECORD LEVEL (L) AND (R) KNOBS

These knobs control the record level of the signals to be recorded through the Dolby Unit. Adjust the knobs so that the Level Meter pointers on the tape recorder do not exceed the 0VU level.

13. PLAY CAL. (L) AND (R) KNOBS

These knobs adjust the playback outputs from a tape deck to the proper Dolby level.

14. DOLBY FM PRESET LEVEL CONTROLS

These factory-adjusted controls govern the FM output level to the Dolby circuit. These controls are for the use of a qualified technician only.

15. 400Hz TONE SWITCH

This is used for calibration of the record input level of the tape deck. When the switch is depressed, the built-in oscillator operates and a 580mV sine wave signal output will be fed to the four TAPE MONITOR OUT jacks.

16. SUGGESTIONS FOR TROUBLESHOOTING POWER AMPLIFIER

16.1 Excessive Line Consumption

- Check for shorted rectifiers H009 and H010; also check C008 and C009.
- Check for shorted transistors H708 and H709. H001, H002, H003, H004, H005, H006, H007 and H008, or check H715. Check for bias transistor H714. Check L004 for short.

CAUTION: BECAUSE THE DRIVER AND OUTPUT STAGES ARE DIRECT COUPLED, COMPONENTS MAY FAIL AS A DIRECT RESULT OF INITIAL COMPONENT FAILURE. IF A SHORTED TRANSISTOR OR ZENER DIODE IS FOUND, OR CONTROL OR BIAS DIODE, BE SURE TO CHECK THE REMAINING DRIVER AND OUTPUT COMPONENTS FOR SHORT OR OPEN CIRCUIT BEFORE REENERGIZING THE AMPLIFIER.

16.2 No Line Consumption of Zero Bias

- Check the line cord, fuse, transistors H715, H001, H002, H003, H004, H005, H006, H007 and H008, and bias transistor H714.
- Check for open rectifiers H009 and H010 or open L004.

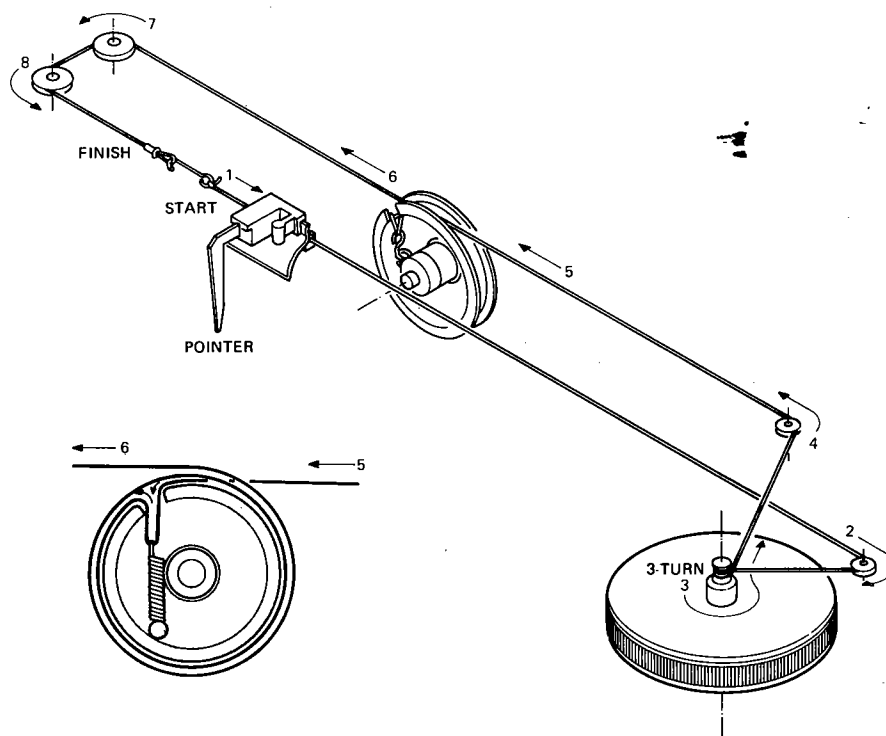

Figure 2. Dial Stringing

17. TEST EQUIPMENT REQUIRED FOR SERVICING

Table 1 lists the test equipment required for servicing the Model 2325 Stereophonic Receiver.

| Item | Manufacturer and Model No. | Use |
|---|---|---|
| AM Signal Generator | | Signal source for AM alignment. |
| Test Loop | | Used with AM Signal generator. |
| FM Signal Generator | Less than 0.3% distortion | Signal source for FM alignment. |
| Stereo Modulator | Less than 0.3% distortion | Stereo separation alignment and trouble shooting. |
| Frequency Counter | | MPX Oscillator adjustment (VCO). |
| Audio Oscillator | Weston Model CVO-100P, less than 0.02% residual distortion is required. | Sinewave and squarewave signal source. |
| Oscilloscope | High sensitivity with DC horizontal and vertical amplifiers. | Waveform analysis and trouble shooting and ASO alignment. |
| VTVM | With AC, DC, RF range | Voltage measurements. |
| Circuit Tester | | Trouble shooting. |
| AC Wattmeter | Simpson, Model 380 | Monitors primary power to Amplifier. |
| AC Ammeter | Commercial Grade (1-10A) | Monitors amplifier output under short circuit condition. |
| Line Voltmeter | Commercial Grade (0-150V AC) | Monitors potential of primary power to amplifier. |
| Variable Autotransformer (0-140V AC, 10 amps) | Powerstat, Model 116B | Adjusts level of primary power to amplifier. |
| Shorting Plug | Use phono plug with 600 ohm across center pin and shell. | Shorts amplifier input to eliminate noise pickup. |
| Output Load (8 ohms, ±1% 100W) | Commercial Grade | Provides 8-ohm load for amplifier output termination. |
| Output Load (4 ohms, ±1% 100W) | Commercial Grade | Provides 4-ohm load for amplifier output termination. |

Table 1. Test Equipment Required for Servicing

18. AM ALIGNMENT PROCEDURES

18.1 AM IF ALIGNMENT

1. Connect a sweep generator to J153 and an alignment scope to the test point ⑥.
2. Turn each core of IF transformer L153 for maximum height and flat top symmetrical response.

18.2 AM Frequency Range and Tracking Alignment

1. Set an AM signal generator to 515kHz. Turn the tuning capacitor fully closed (with the tuning pointer placed at the low end.) and adjust the oscillator coil L152 for maximum audio output.

2. Set the signal generator to 1650kHz. Place the tuning pointer in the high frequency end and adjust the oscillator trimmer on the oscillator tuning capacitor for maximum audio output.
3. Repeat Steps 1 and 2 above until no further adjustment is necessary.
4. Set the signal generator to 600kHz and tune the receiver to the same frequency and adjust the slug core of the AM ferrite rod antenna and RF coil L151 for maximum output.
5. Set the signal generator to 1400kHz and tune the receiver to the same frequency and adjust both trimming capacitors of the antenna and RF tuned circuit for maximum output.
6. Repeat Steps 4 and 5 above until no further adjustment is necessary.

Note: During tracking alignment reduce the signal generator output as necessary to avoid AGC action.

18.3 AM Signal Strength Meter Adjustment

Set the AM Signal generator to 1000kHz with $5\text{K}\mu\text{V}$ output level, and adjust R178 until the signal strength meter may read 80%.

19. FM ALIGNMENT PROCEDURES

1. Connect an FM signal generator to the FM ANTENNA terminals and an oscilloscope and an audio distortion analyzer to the TAPE MONITOR OUT jacks on the rear panel.
2. Set the signal generator to 87.0MHz and provide about 3 to $5\mu\text{V}$. Place the tuning pointer at the low frequency end by turning the tuning knob and adjust the core of the oscillator coil L105 for maximum audio output.
3. Set the signal generator to 109.0MHz and provide about 3 to $5\mu\text{V}$ output. Turn the tuning knob to place the tuning pointer to the high frequency end and adjust the trimming capacitor C106 for maximum output.
4. Repeat Steps 2 and 3 above until no further adjustment is necessary.
5. Set the signal generator to 90MHz and tune the receiver to the same frequency. Decrease the signal generator output until the audio output level decreases with decrease of the signal generator output. Adjust the antenna coil L101, RF coils L102, L103, and L104, and IF transformer L106 for minimum audio distortion.
6. Set the signal generator to 106MHz and tune the receiver to the same frequency. Adjust the trimming capacitors (C102, C103, C104, C105) of the antenna and RF tuning circuits for minimum distortion.
7. Repeat Steps 5 and 6 above until no further adjustment is necessary.
8. Adjust the secondary core (upper) of the discriminator transformer L201 until the center tuning meter pointer indicates its center with no signal applied. Set the signal generator to 98MHz and increase its output level to $1\text{k}\mu\text{V}$ and tune the receiver to the same frequency so that the center tuning meter pointer indicates its center. Adjust the primary core (lower) of L201 for minimum distortion.
9. Set the signal generator to 98MHz with $100\text{k}\mu\text{V}$, and adjust R374 until signal strength meter may read 90%.

19.1 Stereo Separation Alignment

1. Set an FM signal generator to provide $1\text{K}\mu\text{V}$ at 98MHz. Tune the receiver to the same frequency so that the center tuning meter pointer indicates its center. Then turn off the modulation of the signal generator, connect a frequency counter to the test point J310 (point ©) and adjust R311 until the frequency counter may precisely read 19kHz.
2. Modulate the signal generator with the stereo composite signal composed of either L or R channel (of course, the pilot signal must be included).
3. Adjust the trimming resistor R301 for maximum and same separation in both channels.

19.2 Muting Circuit Alignment

1. Connect a VTVM to the tap of the resistor R363 and adjust the resistor R363 until the meter reads 0.75V DC at no signal.
2. Set an FM signal generator to provide 1K μ V at 98MHz and tune the receiver to the same frequency correctly.
3. Turn the MUTING pushswitch on. Shift the FM signal generator frequency higher and lower and note both higher and lower shifted frequencies at which undesirable audio side responses are muted out. Adjust R363 so that the same shifted frequencies mute the undesirable audio side responses.
4. Adjust R362 for preferred frequency shift at which the muting circuit operates.

20. AUDIO ADJUSTMENT

20.1 Automatic Voltage Regulator Adjustment

Connect a DC voltmeter between pins J804 and J805, and adjust the trimming resistor R809 for 35V DC.

20.2 Main Amplifier DC Offset Alignment

Connect a DC voltmeter with 0.5 or 1V range between the speaker terminals and adjust the trimming resistor R713 for "zero" DC output on the meter.

Repeat the same procedure for the other channel.

Note: During this alignment no load should be connected to the speaker terminals.

20.3 Idle-Current Adjustment

Connect a VTVM between pins J702 and J708. Next, rotate the trimming resistor R740 fully counterclockwise, then rotate it clockwise until the VTVM reads 15mV DC (75mA).

Repeat the same procedure for the other channel.

Note: During this alignment no load should be connected to the speaker terminals.

20.4 Main Amplifier DC Offset Re-Alignment

Check the DC offset voltage aligned in the Sec. 20.2 above. If any DC output is observed on the DC voltmeter, adjust R713 again for "zero" output.

20.5 Phono-Amplifier Adjustment

Connect an oscilloscope to the TAPE MONITOR OUT jacks and an audio signal generator to the PHONO jacks. Place the selector switch in the PHONO position. Increase the 1kHz audio signal level gradually until a slight clipping on top of the sine wave is observed on the oscilloscope. Adjust the trimming resistor R408 for equal clipping level.

For the other channel, adjust R409.

21. DOLBY ALIGNMENT PROCEDURE

Prior to the adjustment, turn the PLAY CAL and REC LEVEL controls all the way to the right and the SELECTOR switch to the CD-4/AUX position. Use the CD-4/AUX and TAPE MONITOR OUT jacks for the signal input and output.

21.1

- (1) Set the DOLBY switch to the RECORD I position.
- (2) Adjust the semi-fixed resistor R653 for maximum source voltage of the field-effect transistor H611.

- (3) Connect J620 and J613 to the ground.
- (4) Apply a 5kHz sine wave so as to obtain 17.5mV at J605.
- (5) Record the output level at the TAPE MONITOR OUT jack with the above signal applied.
- (6) Adjust the semi-fixed resistor R659 until the output level at the TAPE MONITOR OUT jack may increase 10 ± 0.25 dB with J620 disconnected from the ground.
- (7) Record the above output level.
- (8) Adjust the semi-fixed resistor R653 until the output level may decrease 2 ± 0.25 dB with J613 disconnected from the ground.
- (9) Connect J613 to the ground again, and assure the level increase in Step (6) above. Disconnect J613.

21.2

- (1) Set the DOLBY switch to the RECORD II position.
- (2) Connect J620 and J613 to the ground.
- (3) Apply a 5kHz sine wave so as to obtain a 44mV at J605.
- (4) Check to insure that the level at the TAPE MONITOR OUT jack decreases 10 ± 0.5 dB with J620 disconnected from the ground.
- (5) Disconnect J620 and J613 from the ground.
- (6) Check to insure that the output voltage at the TAPE MONITOR OUT jack is 17.5mV(± 0.5 dB).

21.3

For the level adjustment, set the DOLBY switch and SELECTOR switch to the RECORD I and CD-4/AUX positions, respectively, and use the TAPE MONITOR OUT jack for the signal output. By setting the 400Hz TONE pushswitch "in", the 400Hz sine wave is fed out. Adjust the semifixed resistor RL11 for 580mV sine wave output voltage in both R and L channels. Then, set the DOLBY switch to the RECORD II position, and apply the 400Hz signal for 580mV output voltage. Adjust the semi-fixed resistors RL28 and RL29 until the DOLBY LEVEL meter may point the Dolby level. Change over the METER switch, and perform this adjustment for both R and L channels.

Next, adjust the semi-fixed resistor RL12 for 580mV output level with the DOLBY switch set to the OFF position. Check the 400Hz output signal level after the level setting of semi-fixed resistors RL11 and RL12. The output level must be precisely 580mV since it is the reference level of the Dolby circuit.

22. DOLBY FM PRESET LEVEL CONTROL ALIGNMENT PROCEDURES

Connect an FM signal generator to the FM antenna. Set the signal generator for 400Hz and 50% modulation.

Set the FM signal generator to 98MHz and the DOLBY switch to the OFF position. Turn the Tuning knob on Model 2325 until it tunes the 98MHz signal from the FM signal generator.

Then, set the DOLBY switch to the DOLBY FM position, and adjust the FM preset level controls RC05 and RC06 until the DOLBY LEVEL meter may point the Dolby level. Change over the METER switch, and perform this adjustment for both R and L channels.

23. DESCRIPTION OF DOLBY PROCESSING CHART

This chart shows the condition of the signals available at the speakers (SPKRS) and at the TAPE MONITOR OUT terminals as a function of different control settings.

To understand the chart refer to the symbols below:

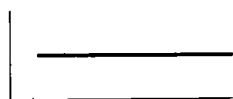

— Represents a signal which has not been applied to either Record or Playback Dolby circuits. The relative amplitudes at all audio frequencies remain unaltered at all levels.

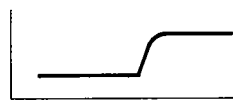

— Represents a signal which has been processed by the Dolby Record circuit. The relative amplitudes at high frequencies are increased at low signal levels.

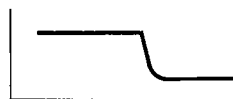

— Represents a signal which has been processed by the Dolby Playback circuit. The relative amplitudes at the high frequencies are decreased at low signal levels.

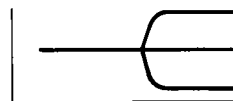

— Represents a signal which has been processed by both the Record and the Playback Dolby circuits.

The Dolby Record and Playback circuits are complementary. Therefore, relative amplitudes at all audio frequencies are restored to their original levels.

| SIGNAL | DOLBY SW | | DOLBY FM | | PLAY | | OFF | | RECORD | | | | | |
|--------------------------|-----------|-----------|----------|----------|--------|----------|--------|----------|--------|----------|-------|----------|-------|----------|
| | TAPES MON | SIGNAL AT | SOURCE | | SOURCE | | SOURCE | | I | | II | | | |
| | | | SPKRS | TAPE OUT | SPKRS | TAPE OUT | SPKRS | TAPE OUT | SPKRS | TAPE OUT | SPKRS | TAPE OUT | | |
| FM TRANSMISSION | ↑ | ↑ | SPKRS | TAPE OUT | SPKRS | TAPE OUT | SPKRS | TAPE OUT | SPKRS | TAPE OUT | SPKRS | TAPE OUT | SPKRS | TAPE OUT |
| NORMAL FM | | | | | | | | | | | | | | |
| DOLBY FM (25 μS W/DOLBY) | | | | | | | | | | | | | | |
| OTHER SOURCE | | | | | | | | | | | | | | |

NOTE: ** DE-EMPHASIS SWITCH IN THE 25 μS POSITION.

Table 2. Dolby Processing Chart

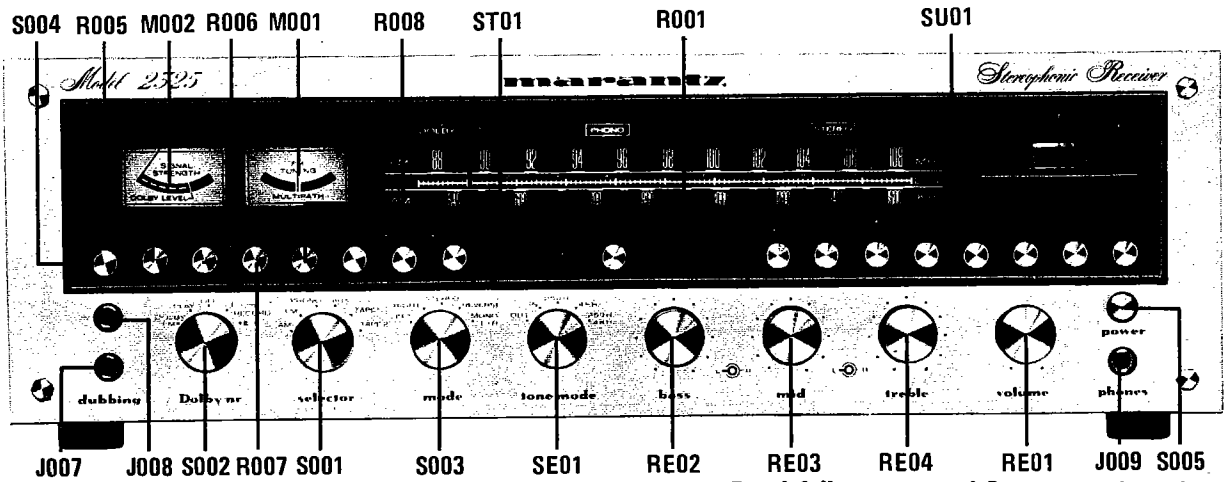

Figure 3. Front Panel Adjustments and Component Locations

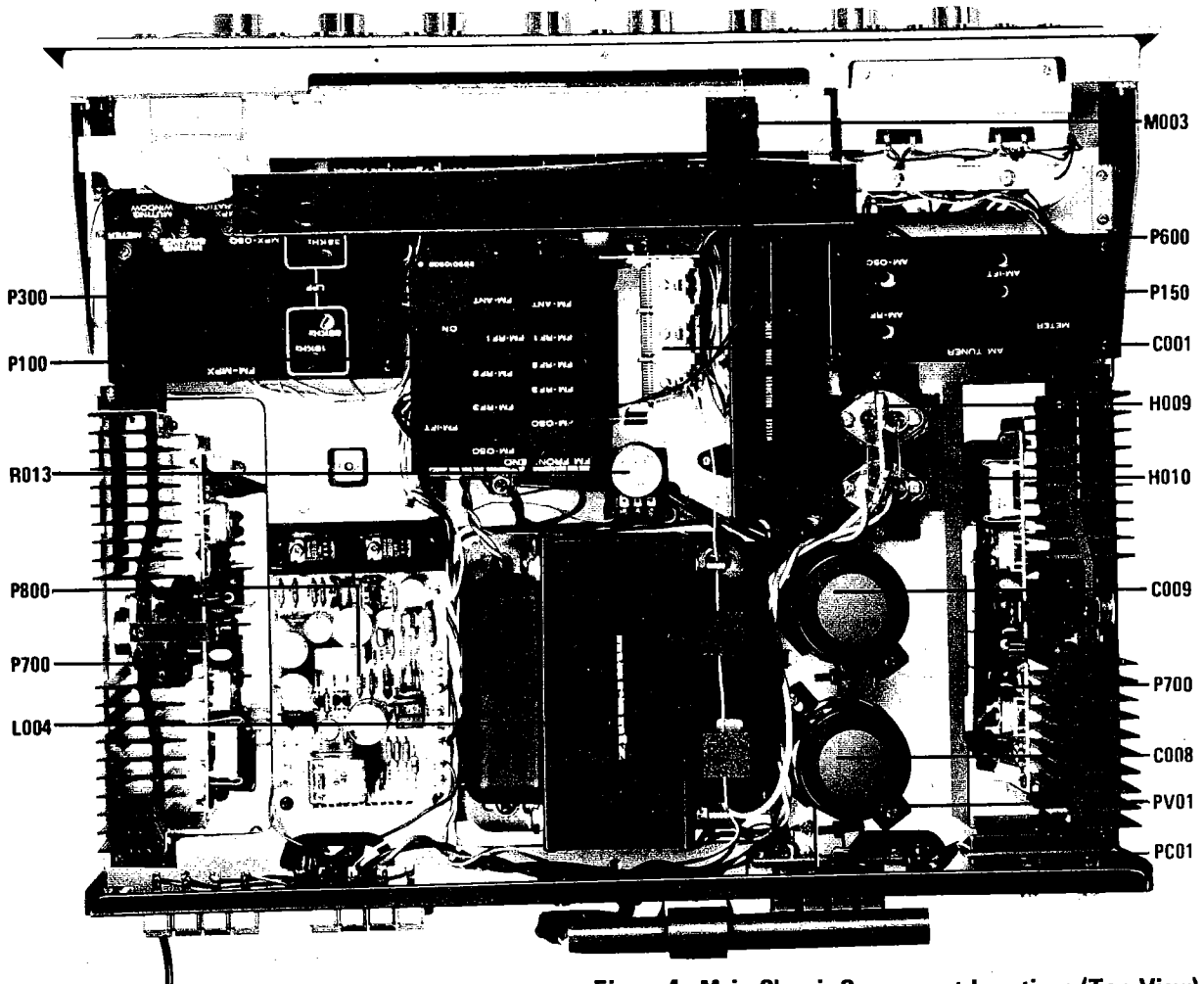

Figure 4. Main Chassis Component Locations (Top View)

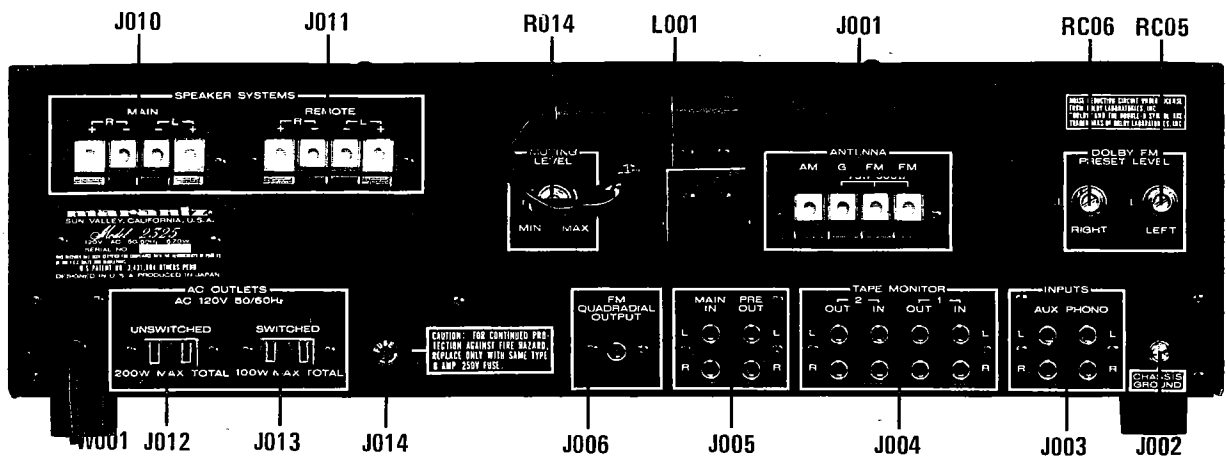

Figure 5. Rear Panel Adjustments and Component Locations

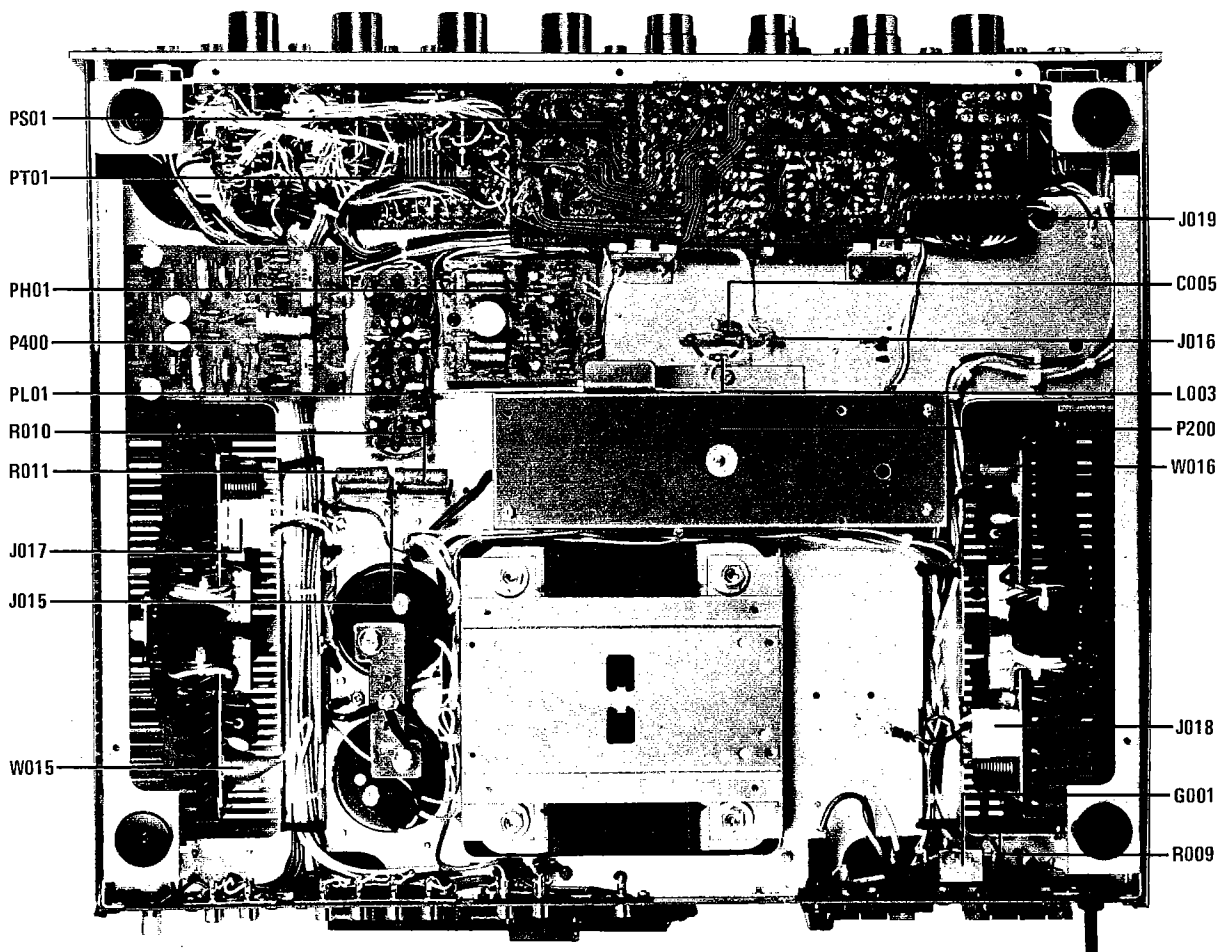

Figure 6. Main Chassis Component Locations (Bottom View)

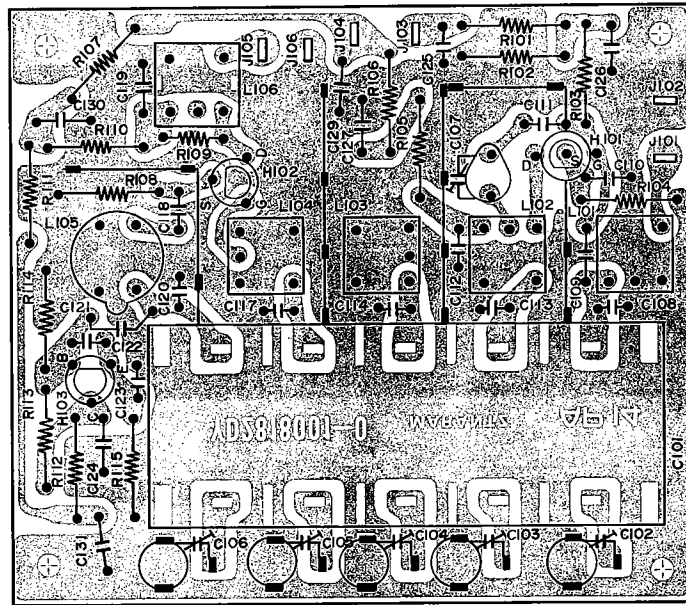

Figure 7. FM Front End Assembly P100 Component Locations

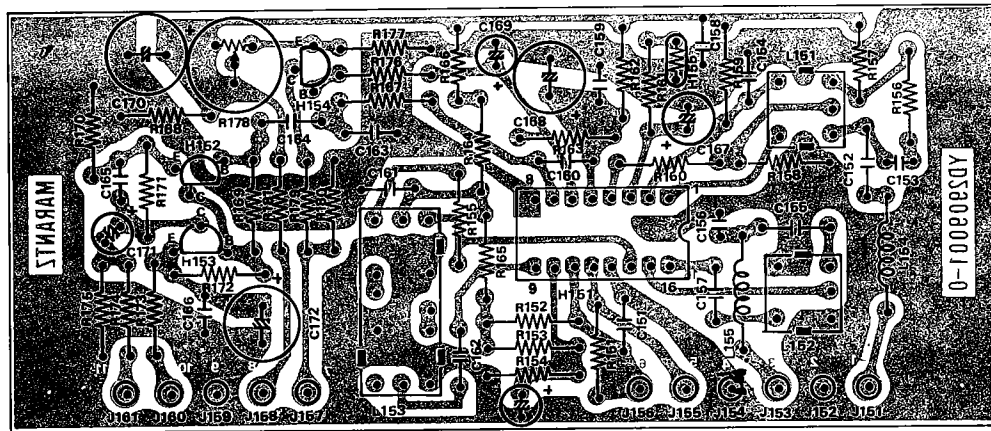

Figure 8. AM Tuner Assembly P150 Component Locations

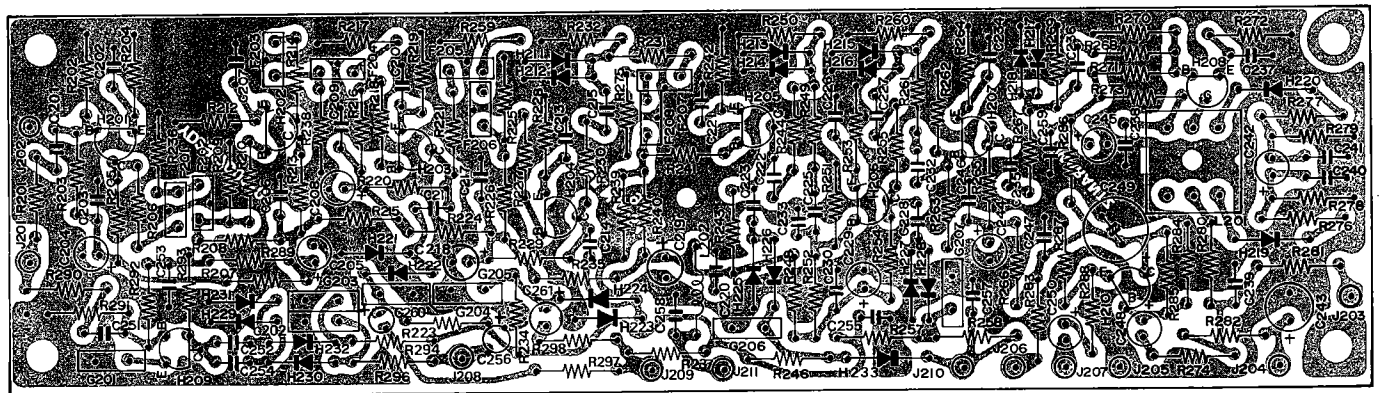

Figure 9. FM IF Amplifier Assembly P200 Component Locations

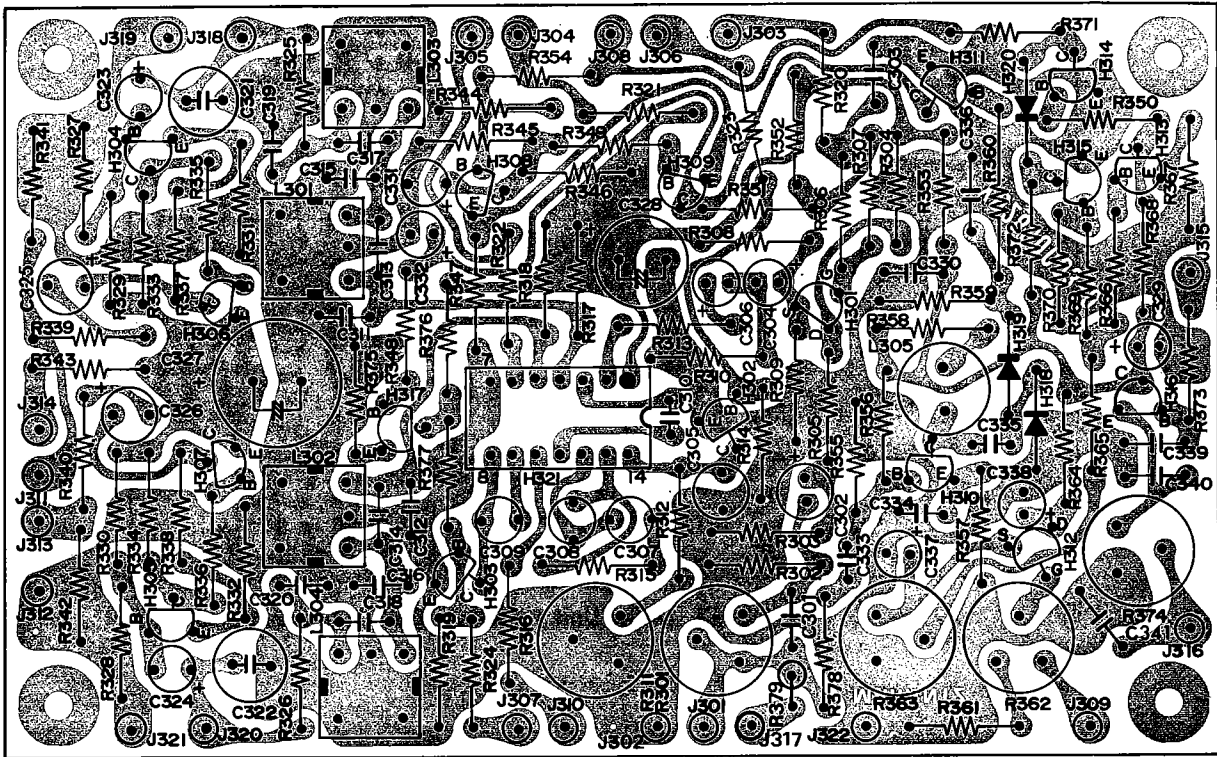

Figure 10. MPX Stereo Decoding Amplifier Assembly P300 Component Locations

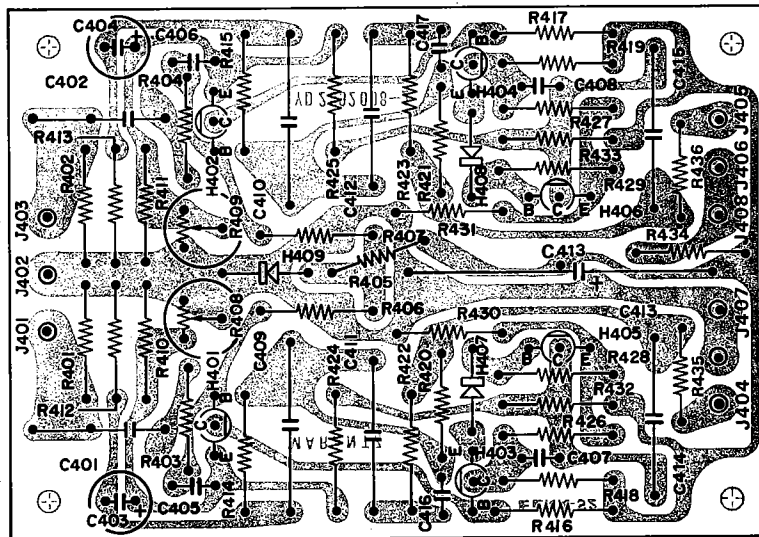

Figure 11. Phono Amplifier Assembly P400 Component Locations

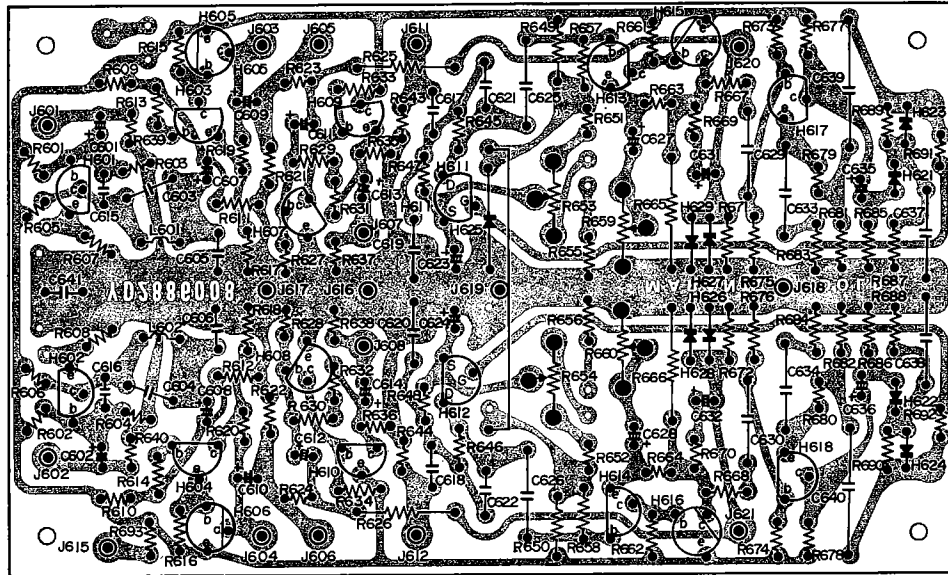

Figure 12. Dolby Unit Assembly P600 Component Locations

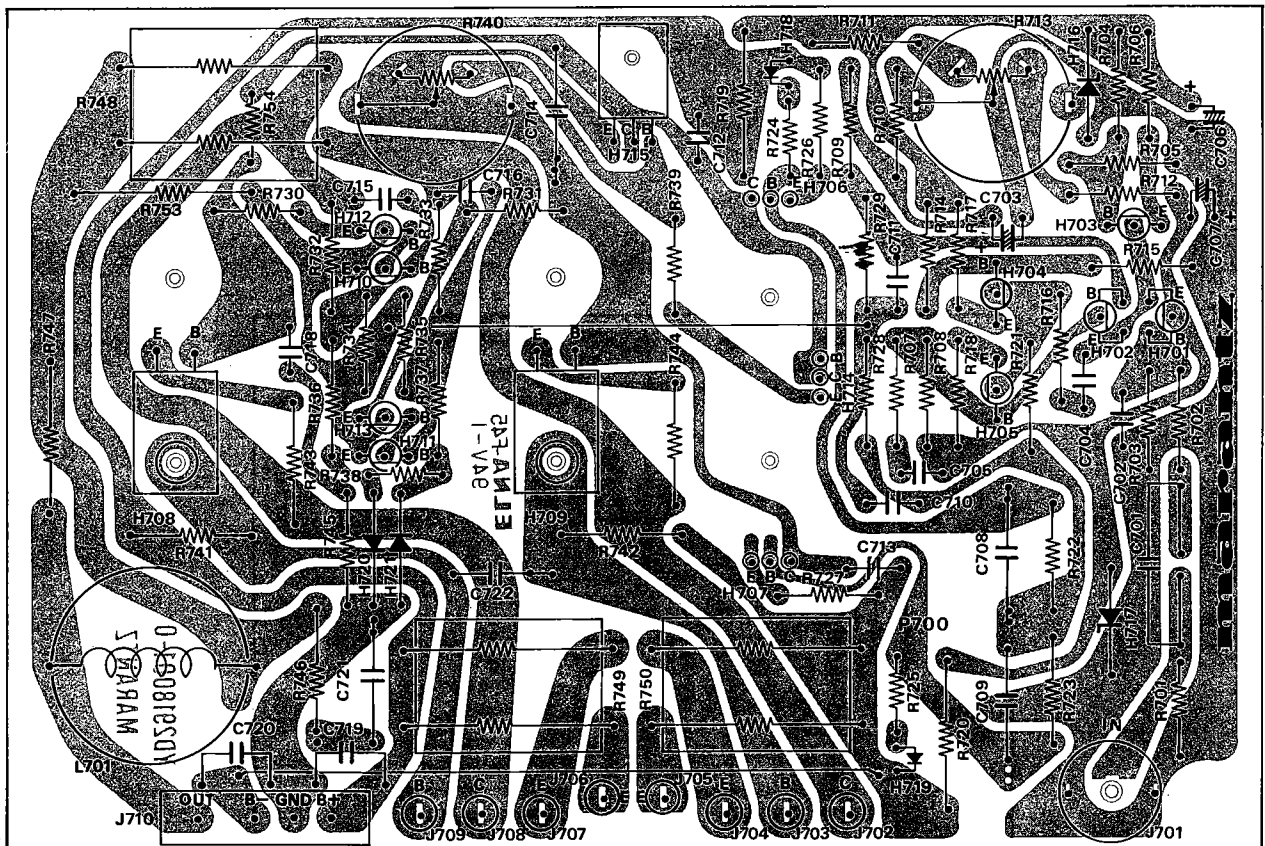

Figure 13. Power Amplifier Assembly P700 Component Locations

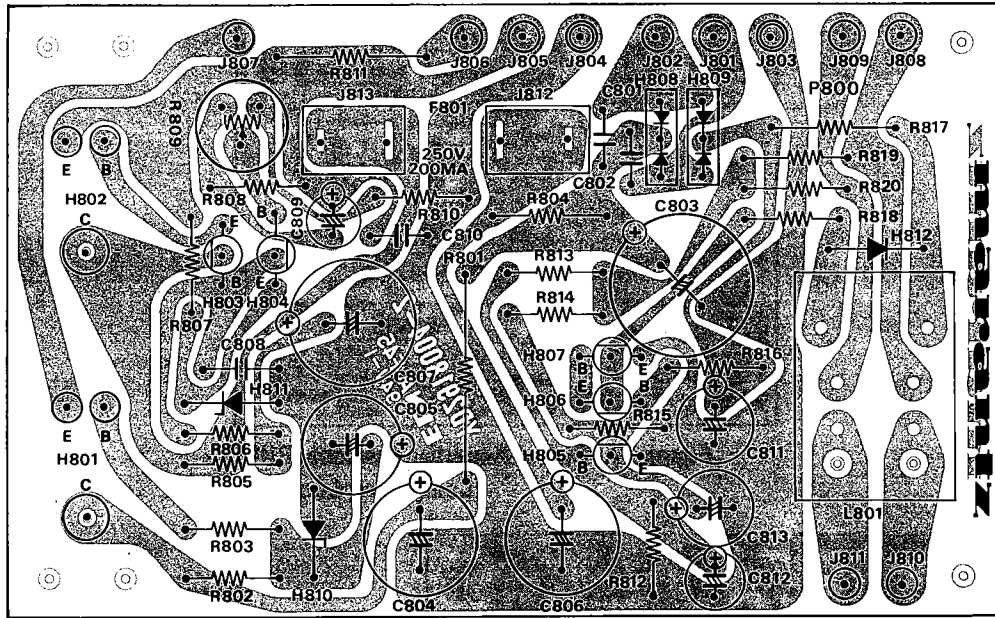

Figure 14. Power Supply and Protection Relay Circuit Assembly P800 Component Locations

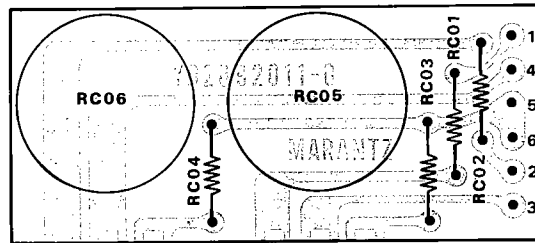

Figure 15. FM Cal. and De-Emphasis Assembly PC01 Component Locations

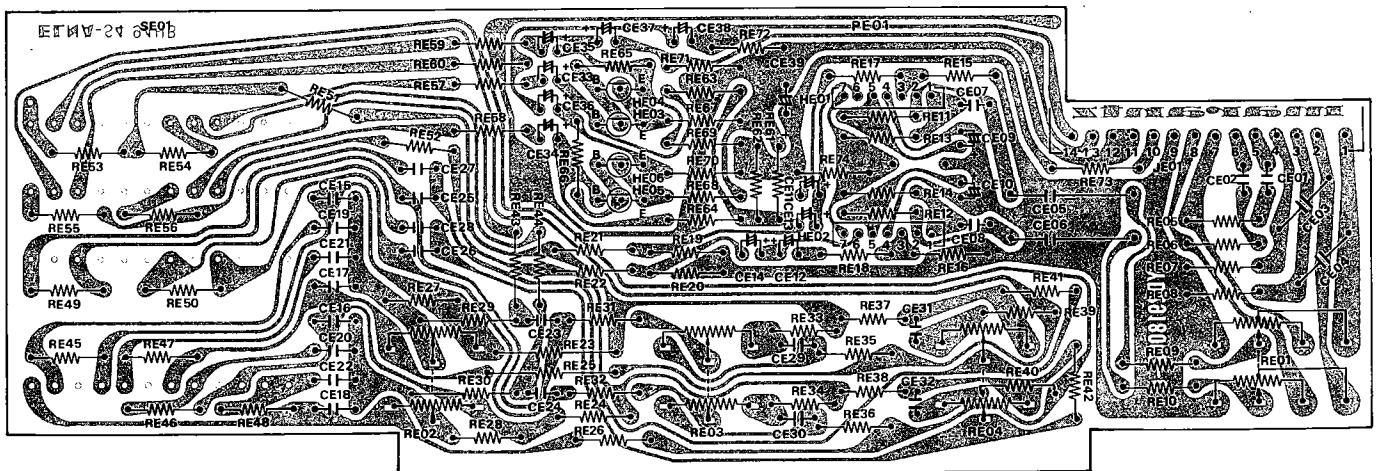

Figure 16. Pre and Tone Amplifier Assembly PE01 Component Locations

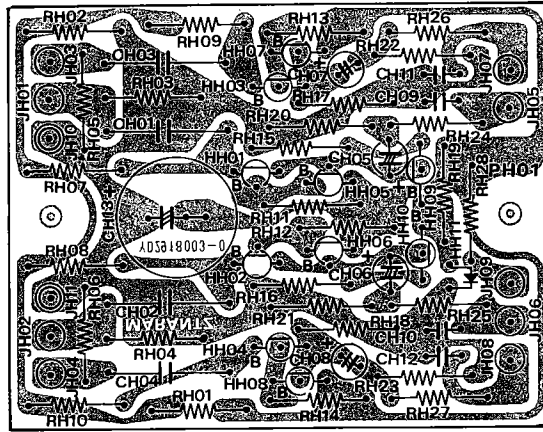

Figure 17. Buffer Amplifier Assembly PH01 Component Locations

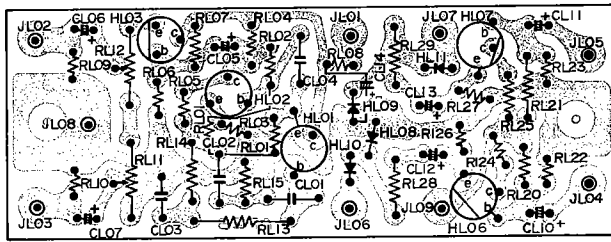

Figure 18. Dolby, Tone and Meter Assembly PL01 Component Locations

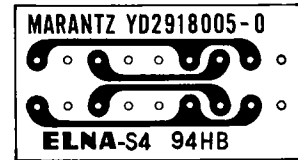

Figure 19. Dolby Tone, Tape Mon. Assembly PS01 Component Locations

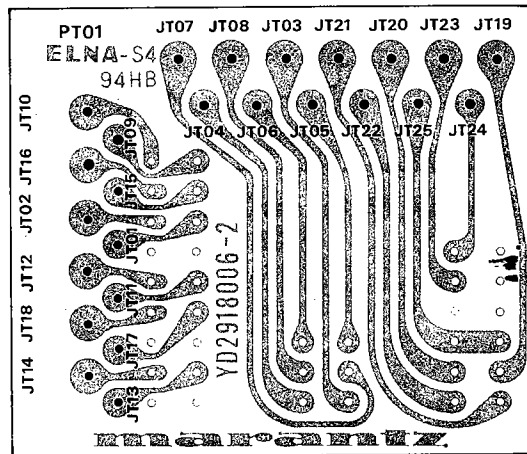

Figure 20. Tape Monitor Assembly PT01 Component Locations

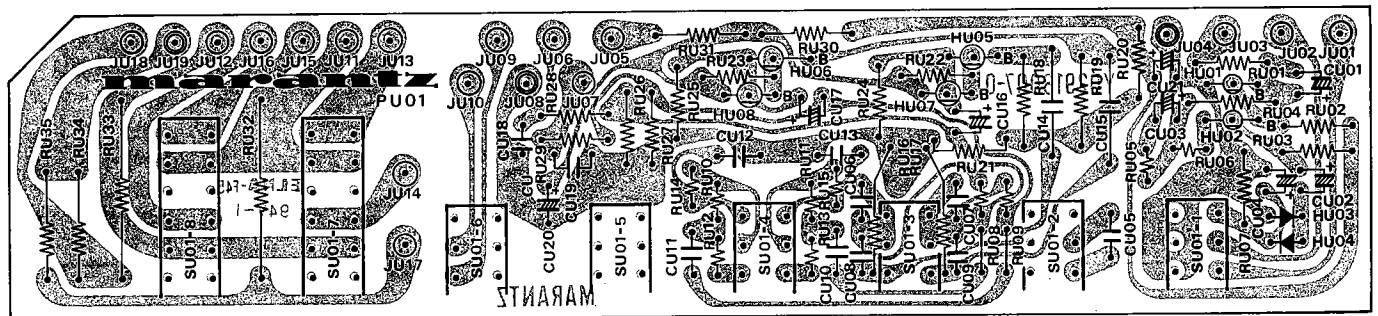

Figure 21. Multipath, Hi Blend, FM Muting, Low Filter, Hi Filter, Loudness, Main Speaker and Remote Speaker Assembly PU01 Component Locations

NOTE

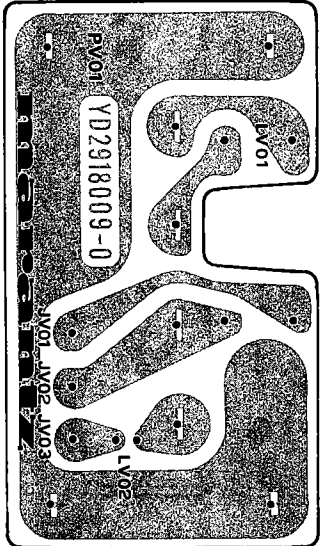

Figure 22. Antenna Terminal Assembly
PY01 Component Locations



Figure 23. Function Lamp Assembly PY01 Component Locations

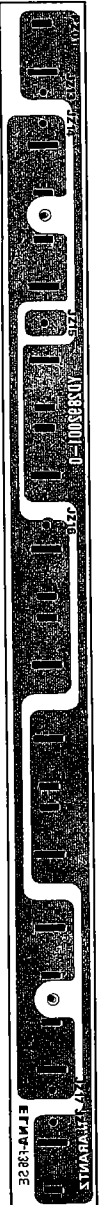

Figure 24. Dial Lamp Assembly PZ01 Component Locations

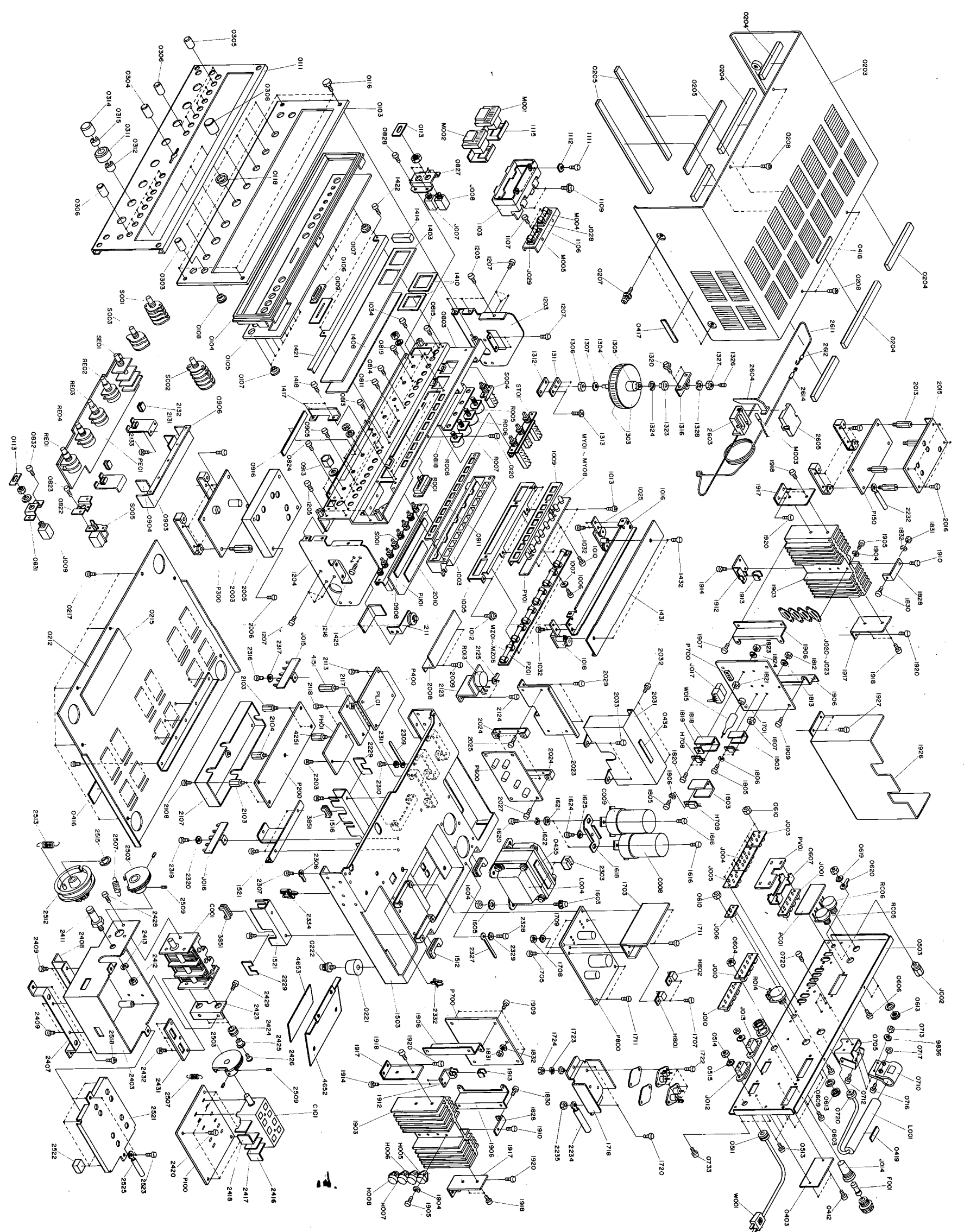

Figure 25. Exploded Mechanical Diagram

PARTS LIST

U U.S.A.
E Europe

| REF. DESIG. | U | E | PART NO. | DESCRIPTION |
|--|----|----|-----------|---------------------------------|
| A | 1 | 1 | 291806340 | Front Panel Assembly |
| 0103 | 1 | 1 | 291806301 | Escutcheon |
| 0104 | 1 | 1 | 289240101 | Frame |
| 0105 | 1 | 1 | 291815801 | Window |
| 0106 | 1 | 1 | 285425901 | Bush |
| 0107 | 12 | 12 | 288625901 | Bush |
| 0108 | 1 | 1 | 288625901 | Bush |
| 0109 | 1 | 1 | 291510701 | Sheet |
| 0111 | 1 | 1 | 291805301 | Cover |
| B | 1 | 1 | 289225742 | Top Lid Assembly |
| 0203 | 1 | 1 | 289225701 | Lid |
| 0204 | 4 | 4 | 257711807 | Spacer |
| 0205 | 3 | 3 | 289205602 | Buffer |
| 0417 | 1 | 1 | 257886102 | Label Do Not Remove |
| 0418 | 1 | 1 | 257886103 | Label See Marking |
| 4651 | 2 | 2 | 291805601 | Buffer |
| C | 1 | 1 | 291825740 | Bottom Lid Assembly |
| 0212 | 1 | 1 | 291825750 | Lid K |
| 0215 | 1 | 1 | 291512001 | Insulator |
| D | 3 | 3 | 281815440 | Knob Assembly, Bottom |
| 0311 | 3 | 3 | 281815404 | Knob |
| 0312 | 3 | 3 | 71400149Q | Spring |
| E | 3 | 3 | 281815441 | Knob Assembly, Top |
| 0314 | 3 | 3 | 281815405 | Knob |
| 0315 | 3 | 3 | 71400159Q | Spring |
| F | 1 | 1 | 291510342 | Pointer Assembly |
| 2603 | 1 | 1 | 291510301 | Pointer |
| 2604 | 1 | 1 | 285010301 | Pointer |
| 2605 | 1 | 1 | 291510302 | Cover |
| M003 | 1 | 1 | IN1008030 | Lamp |
| G | 1 | 1 | 120200640 | Hook Assembly |
| 2611 | 1 | 1 | 72080802A | String |
| 2612 | 1 | 1 | 120225801 | Hook |
| H | 1 | 1 | 285327340 | Fly Wheel Assembly |
| 1303 | 2 | 2 | 257706302 | Escutcheon |
| 1304 | 1 | 1 | 257727301 | Fly Wheel |
| 1305 | 1 | 1 | 285311201 | Shaft |
| 1306 | 1 | 1 | 53110603E | Hexagon Nut |
| 1307 | 1 | 1 | 54020601E | Flat Washer P |
| GENERAL MISCELLANEOUS | | | | |
| 2420 | 4 | 4 | 51100306S | B. H. M. Screw B 3x6 |
| 2507 | 2 | 2 | 71101669Q | Spring |
| 2515 | 1 | 1 | 64000400R | RG Ring E |
| FM FRONT END CIRCUIT BOARD-P100 | | | | |
| P100 | 1 | 1 | YD2818001 | P. W. Board, FM RF (Print Only) |
| | 1 | 1 | ZZ2818001 | P. W. Board Assembly |
| P100-RESISTORS | | | | |
| All resistors are ±5% and ¼W | | | | |
| R101 | 1 | 1 | RT0556314 | 56KΩ |
| R102 | 1 | 1 | RT0510514 | 1MΩ |
| R103 | 1 | 1 | RT0510414 | 100KΩ |
| R104 | 1 | 1 | RT0510114 | 100Ω |
| R105 | 1 | 1 | RT0522114 | 220Ω |
| R106 | 1 | 1 | RT0510114 | 100Ω |
| R107 | 1 | 1 | RT0510114 | 100Ω |
| R108 | 1 | 1 | RT0547214 | 4.7KΩ |
| R109 | 1 | 1 | RT0522314 | 22KΩ |
| R110 | 1 | 1 | RT0510214 | 1KΩ |

| REF. DESIG. | U | E | PART NO. | DESCRIPTION |
|------------------------------|---|---|-----------|------------------------------|
| R111 | 1 | 1 | RT0510114 | 100Ω |
| R112 | 1 | 1 | RT0510114 | 100Ω |
| R113 | 1 | 1 | RT0522314 | 22KΩ |
| R114 | 1 | 1 | RT0522314 | 22KΩ |
| R115 | 1 | 1 | RT0512214 | 1.2KΩ |
| P100-CAPACITORS | | | | |
| C101 | 1 | 1 | CA5000001 | Variable, FM 5 Gang |
| C102 | 1 | 1 | CT1100001 | Trimming, 1.5~11.5PF |
| C103 | 1 | 1 | CT1100001 | Trimming, 1.5~11.5PF |
| C104 | 1 | 1 | CT1100001 | Trimming, 1.5~11.5PF |
| C105 | 1 | 1 | CT1100001 | Trimming, 1.5~11.5PF |
| C106 | 1 | 1 | CT1100001 | Trimming, 1.5~11.5PF |
| C107 | 1 | 1 | CT1100002 | Trimming, 1.5~11.5PF |
| C108 | 1 | 1 | DD1615001 | Ceramic, 15PF±10%, 50V |
| C109 | 1 | 1 | DK1710201 | Ceramic, 1000PF±10%, 50V |
| C110 | 1 | 1 | DK1810301 | Ceramic, 0.1μF+100%,-0%, 50V |
| C111 | 1 | 1 | DD1105001 | Ceramic, 5PF±0.5PF |
| C112 | 1 | 1 | DK1710201 | Ceramic, 1000PF±2% |
| C113 | 1 | 1 | DD1615001 | Ceramic, 15PF±10% |
| C114 | 1 | 1 | DD1620001 | Ceramic, 20PF±10% |
| C115 | 1 | 1 | DD1001002 | Ceramic, 10PF±0.25PF |
| C116 | 1 | 1 | DD1600601 | Ceramic, 0.6PF±10% |
| C117 | 1 | 1 | DD1620001 | Ceramic, 20PF±10% |
| C118 | 1 | 1 | DK1710201 | Ceramic, 1000PF±20% |
| C119 | 1 | 1 | DK1710301 | Ceramic, 0.1μF±20% |
| C120 | 1 | 1 | DD1620003 | Ceramic, 20PF±10% |
| C121 | 1 | 1 | DD1210006 | Ceramic, 10PF±10% |
| C122 | 1 | 1 | DD1615003 | Ceramic, 15PF±10% |
| C123 | 1 | 1 | DD1615003 | Ceramic, 15PF±10% |
| C124 | 1 | 1 | DK1710301 | Ceramic, 0.01μF±20% |
| C125 | 1 | 1 | DK1810301 | Ceramic, 0.01μF+100%,-0% |
| C126 | 1 | 1 | DK1810301 | Ceramic, 0.01μF+100%,-0% |
| C127 | 1 | 1 | DK1710301 | Ceramic, 0.01μF±20% |
| C129 | 1 | 1 | DK1710301 | Ceramic, 0.01μF±20% |
| C130 | 1 | 1 | DK1710301 | Ceramic, 0.01μF±20% |
| C131 | 1 | 1 | DK1710301 | Ceramic, 0.01μF±20% |
| P100-MISCELLANEOUS | | | | |
| L101 | 1 | 1 | LA1027801 | Ant. Coil |
| L102 | 1 | 1 | LA1027802 | RF Coil |
| L103 | 1 | 1 | LA1027803 | RF Coil |
| L104 | 1 | 1 | LA1027804 | RF Coil |
| L105 | 1 | 1 | LO1202604 | OSC Coil |
| L106 | 1 | 1 | LI1001601 | IFT |
| H101 | 1 | 1 | HF200191A | Transistor, 2SK19Y |
| H102 | 1 | 1 | HF200191A | Transistor, 2SK19Y |
| H103 | 1 | 1 | HT305351B | Transistor, 2SC535B |
| J101 | 1 | 1 | YP1000094 | Plug |
| J102 | 1 | 1 | YP1000094 | Plug |
| J103 | 1 | 1 | YP1000094 | Plug |
| J104 | 1 | 1 | YP1000094 | Plug |
| J105 | 1 | 1 | YP1000094 | Plug |
| J106 | 1 | 1 | YP1000094 | Plug |
| GENERAL MISCELLANEOUS | | | | |
| 2416 | 1 | 1 | 281810903 | Shield |
| 2417 | 2 | 2 | 281810904 | Shield |
| 2418 | 1 | 1 | 281810905 | Shield |
| 2403 | 1 | 1 | 281810950 | Shield K |
| 2407 | 1 | 1 | 289016006 | Bracket |
| 2408 | 1 | 1 | 281816008 | Bracket |
| 2409 | 4 | 4 | 51570306B | P.H. Tapt Screw P3 x 6ST |
| 2411 | 1 | 1 | 281811201 | Shaft |

| REF. DESIG. | U | E | PART NO. | DESCRIPTION |
|-------------|---|---|-----------|---|
| 2412 | 1 | 1 | 53110403E | Hexagon Nut |
| 2413 | 1 | 1 | 54040402N | Spring Washer |
| 2423 | 1 | 1 | 281810908 | Shield |
| 2424 | 2 | 2 | 114325901 | Bush |
| 2425 | 2 | 2 | 114325902 | Bush |
| 2426 | 2 | 2 | 51040308A | F. H. M. Screw F 3x8 |
| 2428 | 3 | 3 | 51100304E | B. H. M. Screw B 3x4 |
| 2429 | 2 | 2 | 51100304E | B. H. M. Screw B 3x4 |
| 2431 | 1 | 1 | 281805102 | Guide |
| 2432 | 3 | 3 | 51060306A | P. H. M. Screw P 3x6 |
| C001 | 1 | 1 | CA0330002 | Variable Cap. |
| 2512 | 1 | 1 | 289215901 | Drum |
| 2513 | 1 | 1 | 71101569M | Spring |
| 2503 | 2 | 2 | 281805850 | Gear K |
| 2509 | 4 | 4 | 51064019A | Screw |
| P150 | 1 | 1 | YD2909001 | AM TUNER CIRCUIT BOARD-P150 |
| | 1 | 1 | ZZ2918101 | P. W. Board, AM Tuner (Print Only) P. W. Board Assembly |
| | | | | P150-RESISTORS All resistors are ±5% and ¼W, unless otherwise indicated. |
| R151 | 1 | 1 | RT0510314 | 10KΩ |
| R152 | 1 | 1 | RT0530314 | 30KΩ |
| R153 | 1 | 1 | RT0582314 | 82KΩ |
| R154 | 1 | 1 | RT0522314 | 22KΩ |
| R156 | 1 | 1 | RT0515414 | 150KΩ |
| R157 | 1 | 1 | RC0000014 | 0Ω |
| R158 | 1 | 1 | RT0539314 | 39KΩ |
| R159 | 1 | 1 | RT0539214 | 3.9KΩ |
| R160 | 1 | 1 | RC0000012 | 0Ω |
| R161 | 1 | 1 | RT0543214 | 4.3KΩ |
| R162 | 1 | 1 | RT0510114 | 100Ω |
| R163 | 1 | 1 | RT0515214 | 1.5KΩ |
| R164 | 1 | 1 | RT0533114 | 330Ω |
| R165 | 1 | 1 | RC0000014 | 0Ω |
| R166 | 1 | 1 | RC0000014 | 0Ω |
| R167 | 1 | 1 | RT0522214 | 2.2KΩ |
| R168 | 1 | 1 | RT0582314 | 82KΩ |
| R169 | 1 | 1 | RT0562414 | 620KΩ |
| R170 | 1 | 1 | RT0551114 | 510Ω |
| R171 | 1 | 1 | RT0520214 | 2KΩ |
| R172 | 1 | 1 | RT0556214 | 5.6KΩ |
| R173 | 1 | 1 | RT0510114 | 100Ω |
| R174 | 1 | 1 | RT0510114 | 100Ω |
| R175 | 1 | 1 | RT0510414 | 100KΩ |
| R176 | 1 | 1 | RT0510314 | 10KΩ |
| R177 | 1 | 1 | RT0512314 | 12KΩ |
| R178 | 1 | 1 | RA0103025 | Trimming, 10KΩ (B) |
| R179 | 1 | 1 | RT0512314 | 12KΩ |
| R180 | 1 | 1 | RT0515214 | 1.5KΩ |
| R181 | 1 | 1 | RT0510114 | 100Ω |
| R182 | 1 | 1 | RT0515214 | 1.5KΩ |
| | | | | P150-CAPACITORS |
| C151 | 1 | 1 | DK1710301 | Ceramic, 0.01μF ±20% |
| C152 | 1 | 1 | DF1747305 | Film, 0.047μF ±20% |
| C153 | 1 | 1 | DD1620001 | Ceramic, 20PF ±10% |
| C154 | 1 | 1 | DK1710301 | Ceramic, 0.01μF ±20% |
| C155 | 1 | 1 | DF6545101 | Film, 450PF ±5% |

| REF. DESIG. | U | E | PART NO. | DESCRIPTION |
|-------------|---|---|-----------|---|
| C156 | 1 | 1 | DD1615001 | Ceramic, 15PF ±10% |
| C157 | 1 | 1 | DK1710301 | Ceramic, 0.01μF ±20% |
| C158 | 1 | 1 | DK1840302 | Ceramic, 0.04μF +80%,-20% |
| C159 | 1 | 1 | DK1840302 | Ceramic, 0.04μF +80%,-20% |
| C160 | 1 | 1 | DK1710301 | Ceramic, 0.01μF ±20% |
| C161 | 1 | 1 | DK1710301 | Ceramic, 0.01μF ±20% |
| C162 | 1 | 1 | DK1710301 | Ceramic, 0.01μF ±20% |
| C163 | 1 | 1 | DF1615305 | Film, 0.015μF ±10% |
| C164 | 1 | 1 | DF1633305 | Film, 0.033μF ±10% |
| C165 | 1 | 1 | DF1756205 | Film, 5600PF ±20% |
| C166 | 1 | 1 | DK1840302 | Film, 0.04μF +80%,-20% |
| C167 | 1 | 1 | EA2260169 | Electroly, 22μF, 16V |
| C168 | 1 | 1 | EA1070169 | Electroly, 100μF, 16V |
| C169 | 1 | 1 | EA4750359 | Electroly, 4.7μF, 35V |
| C170 | 1 | 1 | EA1070169 | Electroly, 100μF, 16V |
| C171 | 1 | 1 | EA1050509 | Electroly, 1μF, 50V |
| C172 | 1 | 1 | EA1070169 | Electroly, 100μF, 16V |
| C173 | 1 | 1 | EA4750359 | Electroly, 4.7μF, 35V |
| | | | | P150-MISCELLANEOUS |
| H151 | 1 | 1 | HC1000506 | IC μPC30C |
| H152 | 1 | 1 | HT313272A | Tranistor, 2SC1327 |
| H153 | 1 | 1 | HT104942A | Transistor, 2SA494 |
| H154 | 1 | 1 | HT104942A | Transistor, 2SA494 |
| H155 | 1 | 1 | HH0000212 | Thermistor, 31D27 |
| L151 | 1 | 1 | LA1001019 | RF Coil, AM |
| L152 | 1 | 1 | LO1001050 | OSC Coil, AM |
| L153 | 1 | 1 | LI1028003 | IFT, AM Ceramic Filter |
| L154 | 1 | 1 | LC1332002 | Choke Coil, 3.3μH |
| L155 | 1 | 1 | LC1332002 | Choke Coil, 3.3μH |
| J151 | 1 | 1 | YP1000113 | Plug |
| J152 | 1 | 1 | YP1000113 | Plug |
| J153 | 1 | 1 | YP1000113 | Plug |
| J155 | 1 | 1 | YP1000113 | Plug |
| J156 | 1 | 1 | YP1000113 | Plug |
| J157 | 1 | 1 | YP1000113 | Plug |
| J158 | 1 | 1 | YP1000113 | Plug |
| J159 | 1 | 1 | YP1000113 | Plug |
| J160 | 1 | 1 | YP1000113 | Plug |
| J161 | 1 | 1 | YP1000113 | Plug |
| P200 | 1 | 1 | YD2917001 | FM IF CIRCUIT BOARD-P200 |
| | 1 | 1 | ZZ2918114 | P. W. Board, FM IF (Print Only) P. W. Board Assembly |
| | | | | P200-RESISTORS All resistors are ±5% and ¼W, unless otherwise indicated. |
| R201 | 1 | 1 | RT0515114 | 150Ω |
| R202 | 1 | 1 | RT0582214 | 8.2KΩ |
| R203 | 1 | 1 | RT0518314 | 18KΩ |
| R204 | 1 | 1 | RT0510214 | 1KΩ |
| R205 | 1 | 1 | RT0533114 | 330Ω |
| R206 | 1 | 1 | RC0000014 | 0Ω, ¼W |
| R207 | 1 | 1 | RT0547014 | 47Ω |
| R208 | 1 | 1 | RT0533214 | 3.3KΩ |
| R209 | 1 | 1 | RT0515214 | 1.5KΩ |
| R210 | 1 | 1 | RT0515114 | 150Ω |
| R212 | 1 | 1 | RT0510214 | 1KΩ |
| R213 | 1 | 1 | RT0533114 | 330Ω |
| R214 | 1 | 1 | RC0000014 | 0Ω, ¼W |

| REF. DESIG. | U | E | PART NO. | DESCRIPTION | REF. DESIG. | U | E | PART NO. | DESCRIPTION |
|-------------|---|---|-----------|-------------|-------------|---|---|-----------|---------------------------|
| R215 | 1 | 1 | RT0547014 | 47Ω | R282 | 1 | 1 | RT0522314 | 22KΩ |
| R216 | 1 | 1 | RT0533214 | 3.3KΩ | R283 | 1 | 1 | RT0510114 | 100Ω |
| R217 | 1 | 1 | RT0515214 | 1.5KΩ | R284 | 1 | 1 | RT0510414 | 100KΩ |
| R218 | 1 | 1 | RT0515114 | 150Ω | R285 | 1 | 1 | RT0518414 | 180KΩ |
| R219 | 1 | 1 | RT0510214 | 1KΩ | R286 | 1 | 1 | RT0510114 | 100Ω |
| R220 | 1 | 1 | RT0533114 | 330Ω | R287 | 1 | 1 | RT0522214 | 2.2KΩ |
| R221 | 1 | 1 | RC0000014 | 0Ω, ¼W | R288 | 1 | 1 | RT0510114 | 100Ω |
| R223 | 1 | 1 | RT0547314 | 47KΩ | R289 | 1 | 1 | RT0510114 | 100Ω |
| R224 | 1 | 1 | RT0547014 | 47Ω | R290 | 1 | 1 | RT0512114 | 120Ω |
| R225 | 1 | 1 | RT0515214 | 1.5KΩ | R291 | 1 | 1 | RT0582214 | 8.2KΩ |
| R226 | 1 | 1 | RT0533214 | 3.3KΩ | R292 | 1 | 1 | RT0518314 | 18KΩ |
| R227 | 1 | 1 | RT0515114 | 150Ω | R293 | 1 | 1 | RT0522214 | 2.2KΩ |
| R228 | 1 | 1 | RT0556114 | 560Ω | R294 | 1 | 1 | RT0527314 | 27KΩ |
| R229 | 1 | 1 | RT0575014 | 75Ω | R296 | 1 | 1 | RT0533314 | 33KΩ |
| R230 | 1 | 1 | RC0000014 | 0Ω, ¼W | R297 | 1 | 1 | RT0522314 | 22KΩ |
| R231 | 1 | 1 | RT0575014 | 75Ω | R298 | 1 | 1 | RT0515314 | 15KΩ |
| R232 | 1 | 1 | RT0510414 | 100KΩ | | | | | P200-CAPACITORS |
| R234 | 1 | 1 | RT0568314 | 68KΩ | C201 | 1 | 1 | DK1810301 | Ceramic, 0.01μF +80%,-20% |
| R235 | 1 | 1 | RT0547014 | 47Ω | C202 | 1 | 1 | DK1810301 | Ceramic, 0.01μF +80%,-20% |
| R236 | 1 | 1 | RT0582114 | 820Ω | C203 | 1 | 1 | DK1840302 | Ceramic, 0.04μF +80%,-20% |
| R237 | 1 | 1 | RT0510214 | 1KΩ | C204 | 1 | 1 | EA1060169 | Electroly, 10μF, 16V |
| R238 | 1 | 1 | RT0582114 | 820Ω | C205 | 1 | 1 | EA1060169 | Electroly, 10μF, 16V |
| R239 | 1 | 1 | RT0515214 | 1.5KΩ | C206 | 1 | 1 | DK1840302 | Ceramic, 0.04μF +80%,-20% |
| R240 | 1 | 1 | RT0533214 | 3.3KΩ | C207 | 1 | 1 | DK1810301 | Ceramic, 0.01μF +80%,-20% |
| R241 | 1 | 1 | RT0515114 | 150Ω | C208 | 1 | 1 | EA1060169 | Electroly, 10μF, 16V |
| R242 | 1 | 1 | RT0510214 | 1KΩ | C209 | 1 | 1 | DK1840302 | Ceramic, 0.04μF +80%,-20% |
| R243 | 1 | 1 | RT0510214 | 1KΩ | C210 | 1 | 1 | DK1810301 | Ceramic, 0.01μF +80%,-20% |
| R244 | 1 | 1 | RT0515114 | 150Ω | C211 | 1 | 1 | DD1540001 | Ceramic, 40PF ±5% |
| R246 | 1 | 1 | RT0568314 | 68KΩ | C213 | 1 | 1 | DK1810301 | Ceramic, 0.01μF +80%,-20% |
| R248 | 1 | 1 | RT0547014 | 47Ω | C214 | 1 | 1 | DD1540001 | Ceramic, 40PF ±5% |
| R249 | 1 | 1 | RT0515114 | 150Ω | C215 | 1 | 1 | DK1810301 | Ceramic, 0.01μF +80%,-20% |
| R250 | 1 | 1 | RT0510414 | 100KΩ | C217 | 1 | 1 | DK1840302 | Ceramic, 0.04μF +80%,-20% |
| R251 | 1 | 1 | RT0582214 | 8.2KΩ | C218 | 1 | 1 | EA1060169 | Electroly, 10μF, 16V |
| R252 | 1 | 1 | RT0515314 | 15KΩ | C219 | 1 | 1 | EA1060169 | Electroly, 10μF, 16V |
| R253 | 1 | 1 | RT0510214 | 1KΩ | C220 | 1 | 1 | DK1840302 | Ceramic, 0.04μF +80%,-20% |
| R254 | 1 | 1 | RT0510214 | 1KΩ | C221 | 1 | 1 | DK1810301 | Ceramic, 0.01μF +80%,-20% |
| R255 | 1 | 1 | RT0515114 | 150Ω | C222 | 1 | 1 | DK1810301 | Ceramic, 0.01μF +80%,-20% |
| R257 | 1 | 1 | RT0539314 | 39KΩ | C223 | 1 | 1 | DD1540001 | Ceramic, 40PF ±5% |
| R258 | 1 | 1 | RT0522314 | 22KΩ | C225 | 1 | 1 | DK1810301 | Ceramic, 0.01μF +80%,-20% |
| R259 | 1 | 1 | RT0582114 | 820Ω | C226 | 1 | 1 | DK1810301 | Ceramic, 0.01μF +80%,-20% |
| R260 | 1 | 1 | RT0510414 | 100KΩ | C227 | 1 | 1 | DK1810301 | Ceramic, 0.01μF +80%,-20% |
| R261 | 1 | 1 | RT0515114 | 150Ω | C228 | 1 | 1 | DD1540001 | Ceramic, 40PF ±5% |
| R262 | 1 | 1 | RT0582214 | 8.2KΩ | C229 | 1 | 1 | EA1060169 | Electroly, 10μF, 16V |
| R263 | 1 | 1 | RT0515314 | 15KΩ | C230 | 1 | 1 | DK1840302 | Ceramic, 0.04μF +80%,-20% |
| R264 | 1 | 1 | RT0510214 | 1KΩ | C232 | 1 | 1 | DK1810301 | Ceramic, 0.01μF +80%,-20% |
| R265 | 1 | 1 | RT0510214 | 1KΩ | C233 | 1 | 1 | DD1540001 | Ceramic, 40PF ±5% |
| R266 | 1 | 1 | RT0510114 | 100Ω | C234 | 1 | 1 | DK1810301 | Ceramic, 0.01μF +80%,-20% |
| R267 | 1 | 1 | RT0515114 | 150Ω | C235 | 1 | 1 | DK1810301 | Ceramic, 0.01μF +80%,-20% |
| R268 | 1 | 1 | RT0515114 | 150Ω | C236 | 1 | 1 | DK1810301 | Ceramic, 0.01μF +80%,-20% |
| R269 | 1 | 1 | RT0510414 | 100KΩ | C237 | 1 | 1 | DK1810301 | Ceramic, 0.01μF +80%,-20% |
| R270 | 1 | 1 | RT0582214 | 8.2KΩ | C238 | 1 | 1 | DK1840302 | Ceramic, 0.04μF +80%,-20% |
| R271 | 1 | 1 | RT0515314 | 15KΩ | C239 | 1 | 1 | DD1620101 | Ceramic, 200PF ±10% |
| R272 | 1 | 1 | RT0510214 | 1KΩ | C240 | 1 | 1 | DD1620101 | Ceramic, 200PF ±10% |
| R273 | 1 | 1 | RT0510114 | 100Ω | C241 | 1 | 1 | DD1620101 | Ceramic, 200PF ±10% |
| R274 | 1 | 1 | RT0527214 | 2.7KΩ | C242 | 1 | 1 | EA1060169 | Electroly, 10μF, 16V |
| R275 | 1 | 1 | RT0582114 | 820Ω | C243 | 1 | 1 | EA1070109 | Electroly, 100μF, 10V |
| R276 | 1 | 1 | RT0582114 | 820Ω | C244 | 1 | 1 | EA1060169 | Electroly, 100μF, 10V |
| R277 | 1 | 1 | RT0582114 | 820Ω | C245 | 1 | 1 | EA1060169 | Electroly, 100μF, 10V |
| R278 | 1 | 1 | RT0568214 | 6.8KΩ | C246 | 1 | 1 | DK1840302 | Ceramic, 0.04μF +80%,-20% |
| R279 | 1 | 1 | RT0568214 | 6.8KΩ | C247 | 1 | 1 | DK1840302 | Ceramic, 0.04μF +80%,-20% |
| R280 | 1 | 1 | RT0510114 | 100Ω | C148 | 1 | 1 | EA1060169 | Electroly, 10μF, 16V |
| R281 | 1 | 1 | RT0556314 | 56KΩ | | | | | |

| REF. DESIG. | U | E | PART NO. | DESCRIPTION |
|----------------------------|---|---|-----------|---------------------------|
| C249 | 1 | 1 | EA1070169 | Electroly, 100μF, 16V |
| C250 | 1 | 1 | EA2260169 | Electroly, 22μF, 16V |
| C251 | 1 | 1 | DK1810301 | Ceramic, 0.01μF +80%,-20% |
| C252 | 1 | 1 | DD1540001 | Ceramic, 40PF ±5% |
| C253 | 1 | 1 | DK1840302 | Ceramic, 0.04μF +80%,-20% |
| C254 | 1 | 1 | DD1540001 | Ceramic, 40PF ±5% |
| C255 | 1 | 1 | DD1620101 | Ceramic, 200PF ±10% |
| C256 | 1 | 1 | EV1050352 | Electroly, 1μF ±20%, 35V |
| C257 | 1 | 1 | DD1620101 | Ceramic, 200PF ±10% |
| C258 | 1 | 1 | DK1810301 | Ceramic, 0.01μF +80%,-20% |
| C259 | 1 | 1 | DK1840302 | Ceramic, 0.04μF +80%,-20% |
| C260 | 1 | 1 | EV1050352 | Electroly, 1μF, 35V |
| C261 | 1 | 1 | EA1050509 | Electroly, 1μF, 50V |
| C262 | 1 | 1 | DK1810402 | Ceramic, 0.1μF +80%,-20% |
| C263 | 1 | 1 | DK1810402 | Ceramic, 0.1μF +80%,-20% |
| P200-SEMICONDUCTORS | | | | |
| H201 | 1 | 1 | HT308291C | Transistor, 2SC829C |
| H202 | 1 | 1 | HT308291C | Transistor, 2SC829C |
| H203 | 1 | 1 | HT308291C | Transistor, 2SC829C |
| H204 | 1 | 1 | HT308291C | Transistor, 2SC829C |
| H205 | 1 | 1 | HT308291C | Transistor, 2SC829C |
| H206 | 1 | 1 | HT308291C | Transistor, 2SC829C |
| H207 | 1 | 1 | HT308291C | Transistor, 2SC829C |
| H208 | 1 | 1 | HT308291C | Transistor, 2SC829C |
| H209 | 1 | 1 | HT308291C | Transistor, 2SC829C |
| H210 | 1 | 1 | HT306441B | Transistor, 2SC644S |
| H211 | 1 | 1 | HD2000121 | Diode, 1S2413 |
| H212 | 1 | 1 | HD2000121 | Diode, 1S2413 |
| H213 | 1 | 1 | HD2000121 | Diode, 1S2413 |
| H214 | 1 | 1 | HD2000121 | Diode, 1S2413 |
| H215 | 1 | 1 | HD2000121 | Diode, 1S2413 |
| H216 | 1 | 1 | HD2000121 | Diode, 1S2413 |
| H217 | 1 | 1 | HD2000121 | Diode, 1S2413 |
| H218 | 1 | 1 | HD2000121 | Diode, 1S2413 |
| H219 | 1 | 1 | HD1000302 | Diode, 20A90M |
| H220 | 1 | 1 | HD1000302 | Diode, 20A90M |
| H221 | 1 | 1 | HD1000105 | Diode, 1N60 |
| H222 | 1 | 1 | HD1000105 | Diode, 1N60 |
| H223 | 1 | 1 | HD1000105 | Diode, 1N60 |
| H224 | 1 | 1 | HD1000105 | Diode, 1N60 |
| H225 | 1 | 1 | HD1000105 | Diode, 1N60 |
| H226 | 1 | 1 | HD1000105 | Diode, 1N60 |
| H227 | 1 | 1 | HD1000105 | Diode, 1N60 |
| H228 | 1 | 1 | HD1000105 | Diode, 1N60 |
| H229 | 1 | 1 | HD1000105 | Diode, 1N60 |
| H230 | 1 | 1 | HD1000105 | Diode, 1N60 |
| H231 | 1 | 1 | HD1000105 | Diode, 1N60 |
| H232 | 1 | 1 | HD1000105 | Diode, 1N60 |
| H233 | 1 | 1 | HD1000302 | Diode, 20A90M |
| P200-MISCELLANEOUS | | | | |
| F201 | 1 | 1 | FP1107001 | Ceramic Filter, SFA107MC |
| F202 | 1 | 1 | FP1107001 | Ceramic Filter, SFA107MC |
| F203 | 1 | 1 | FP1107001 | Ceramic Filter, SFA107MC |
| F204 | 1 | 1 | FP1107001 | Ceramic Filter, SFA107MC |
| F205 | 1 | 1 | FP1107001 | Ceramic Filter, SFA107MC |
| F206 | 1 | 1 | FP1107001 | Ceramic Filter, SFA107MC |
| F207 | 1 | 1 | FP1107001 | Ceramic Filter, SFA107MC |
| F208 | 1 | 1 | FP1107001 | Ceramic Filter, SFA107MC |
| L201 | 1 | 1 | LI1401623 | IFT, FM Detector |
| L202 | 1 | 1 | LC1332002 | Choke Coil, 3.3μH |

| REF. DESIG. | U | E | PART NO. | DESCRIPTION |
|---|---|---|-----------|---------------------------------------|
| J201 | 1 | 1 | YP1000113 | Plug |
| J202 | 1 | 1 | YP1000113 | Plug |
| J203 | 1 | 1 | YP1000113 | Plug |
| J204 | 1 | 1 | YP1000113 | Plug |
| J205 | 1 | 1 | YP1000113 | Plug |
| J206 | 1 | 1 | YP1000113 | Plug |
| J207 | 1 | 1 | YP1000113 | Plug |
| J208 | 1 | 1 | YP1000113 | Plug |
| J209 | 1 | 1 | YP1000113 | Plug |
| J210 | 1 | 1 | YP1000113 | Plug |
| J211 | 1 | 1 | YP1000113 | Plug |
| G201 | 1 | 1 | BF2230006 | Printed Compo. 1KΩ+0.022μF |
| G202 | 1 | 1 | BF1020002 | Printed Compo. 100KΩ+1000PF |
| G203 | 1 | 1 | BF1020001 | Printed Compo. 27KΩ+1000PF |
| G204 | 1 | 1 | BF2010004 | Printed Compo. 27KΩ+200PF |
| G205 | 1 | 1 | BF2010004 | Printed Compo. 27KΩ+200PF |
| G206 | 1 | 1 | BF2010004 | Printed Compo. 27KΩ+200PF |
| G207 | 1 | 1 | BF2010004 | Printed Compo. 27KΩ+200PF |
| FM MPX CIRCUIT BOARD-P300 | | | | |
| P300 | 1 | 1 | YD2890003 | P.W. Board, FM Multiplex (Print Only) |
| | | | ZZ2918103 | P. W. Board Assembly |
| P300-RESISTORS | | | | |
| All resistors are ±5% and ¼W, unless otherwise indicated. | | | | |
| R301 | 1 | 1 | RA0202011 | Trimming, 2KΩ (B) |
| R302 | 1 | 1 | RT0522414 | 220KΩ |
| R303 | 1 | 1 | RT0556314 | 56KΩ |
| R304 | 1 | 1 | RT0568314 | 68KΩ |
| R305 | 1 | 1 | RT0510114 | 100Ω |
| R306 | 1 | 1 | RT0518414 | 180KΩ |
| R307 | 1 | 1 | RT0522414 | 220KΩ |
| R308 | 1 | 1 | RT0512414 | 120KΩ |
| R309 | 1 | 1 | RT0510414 | 100KΩ |
| R310 | 1 | 1 | RT0568214 | 6.8KΩ |
| R311 | 1 | 1 | RA0502020 | Trimming, 5KΩ (B) |
| R312 | 1 | 1 | RT0516314 | 16KΩ |
| R313 | 1 | 1 | RT0510214 | 1KΩ |
| R314 | 1 | 1 | RT0522414 | 220KΩ |
| R315 | 1 | 1 | RT0510214 | 1KΩ |
| R316 | 1 | 1 | RT0510214 | 1KΩ |
| R317 | 1 | 1 | RT0539214 | 3.9KΩ |
| R318 | 1 | 1 | RT0539214 | 3.9KΩ |
| R319 | 1 | 1 | RT0522414 | 220KΩ |
| R320 | 1 | 1 | RT0522314 | 22KΩ |
| R321 | 1 | 1 | RT0510114 | 100Ω |
| R322 | 1 | 1 | RT0510014 | 10Ω |
| R323 | 1 | 1 | RT0522414 | 220KΩ |
| R324 | 1 | 1 | RT0522414 | 220KΩ |
| R325 | 1 | 1 | RT0530314 | 30KΩ |
| R326 | 1 | 1 | RT0530314 | 30KΩ |
| R327 | 1 | 1 | RT0510414 | 100KΩ |
| R328 | 1 | 1 | RT0510414 | 100KΩ |
| R329 | 1 | 1 | RT0515514 | 1.5MΩ |
| R330 | 1 | 1 | RT0515514 | 1.5MΩ |
| R331 | 1 | 1 | RT0551114 | 510Ω |
| R332 | 1 | 1 | RT0551114 | 510Ω |
| R332 | 1 | 1 | RT0551114 | 510Ω |
| R333 | 1 | 1 | RT0522314 | 22KΩ |
| R334 | 1 | 1 | RT0522314 | 22KΩ |
| R335 | 1 | 1 | RT0510114 | 100Ω |
| R336 | 1 | 1 | RT0510114 | 100Ω |

U U.S.A.
E Europe

| REF. DESIG. | U | E | PART NO. | DESCRIPTION | REF. DESIG. | U | E | PART NO. | DESCRIPTION |
|------------------------|---|---|-----------|-----------------------------|--------------------------------------|---|---|-----------|-------------------------------------|
| R337 | 1 | 1 | RT0582214 | 8.2KΩ | C320 | 1 | 1 | DF1522205 | Film, 2200PF ±5% |
| R338 | 1 | 1 | RT0582214 | 8.2KΩ | C321 | 1 | 1 | DF1510205 | Film, 1000PF ±5% |
| R339 | 1 | 1 | RT0547114 | 470Ω | C322 | 1 | 1 | DF1510205 | Film, 1000PF ±5% |
| R340 | 1 | 1 | RT0547114 | 470Ω | C323 | 1 | 1 | EV2240351 | Electroly, 0.22μF ±20%, 35V |
| R341 | 1 | 1 | RT0522414 | 220KΩ | C324 | 1 | 1 | EV2240351 | Electroly, 0.22μF ±20%, 35V |
| R342 | 1 | 1 | RT0522414 | 220KΩ | C325 | 1 | 1 | EV1050352 | Electroly, 1μF ±20%, 35V |
| R343 | 1 | 1 | RT0539214 | 3.9KΩ | C326 | 1 | 1 | EV1050352 | Electroly, 1μF ±20%, 35V |
| R344 | 1 | 1 | RT0556414 | 560KΩ | C327 | 1 | 1 | EA2270259 | Electroly, 220μF, 25V |
| R345 | 1 | 1 | RT0515314 | 15KΩ | C328 | 1 | 1 | EA2270169 | Electroly, 220μF, 16V |
| R346 | 1 | 1 | RT0512414 | 120KΩ | C329 | 1 | 1 | EA1060169 | Electroly, 10μF, 16V |
| R347 | 1 | 1 | RT0510114 | 100Ω | C330 | 1 | 1 | DK1840302 | Ceramic, 0.04μF +80%,-20% |
| R348 | 1 | 1 | RT0522414 | 220KΩ | C331 | 1 | 1 | EA1050509 | Electroly, 1μF, 50V |
| R349 | 1 | 1 | RT0556214 | 5.6KΩ | C332 | 1 | 1 | EA1060169 | Electroly, 10μF, 16V |
| R350 | 1 | 1 | RT0510314 | 10KΩ | C333 | 1 | 1 | DD1210001 | Ceramic, 10PF ±10% |
| R351 | 1 | 1 | RT0510114 | 100Ω | C334 | 1 | 1 | DF1668301 | Film, 0.068μF ±10% |
| R352 | 1 | 1 | RT0533314 | 33KΩ | C335 | 1 | 1 | DF1740301 | Film, 0.04μF ±20% |
| R353 | 1 | 1 | RT0510114 | 100Ω | C336 | 1 | 1 | DK1810402 | Ceramic, 0.1μF +80%,-20% |
| R354 | 1 | 1 | RT0510414 | 100KΩ | C337 | 1 | 1 | EA4750359 | Electroly, 4.7μF, 35V |
| R355 | 1 | 1 | RT0527314 | 27KΩ | C338 | 1 | 1 | EA1050509 | Electroly, 1μF, 50V |
| R356 | 1 | 1 | RT0510414 | 100KΩ | C339 | 1 | 1 | DK1840302 | Ceramic, 0.04μF +80%,-20% |
| R357 | 1 | 1 | RT0510214 | 1KΩ | C340 | 1 | 1 | DK1840302 | Ceramic, 0.04μF +80%,-20% |
| R358 | 1 | 1 | RT0510114 | 100Ω | C341 | 1 | 1 | DK1840302 | Ceramic, 0.04μF +80%,-20% |
| R359 | 1 | 1 | RT0527314 | 27KΩ | C343 | 1 | 1 | DF1710402 | Film, 0.1μF ±20% |
| R360 | 1 | 1 | RT0533314 | 33KΩ | C344 | 1 | 1 | DK1820302 | Ceramic, 0.02μF +80%,-20% |
| R361 | 1 | 1 | RT0510414 | 100KΩ | P300-COILS & PLUGS | | | | |
| R362 | 1 | 1 | RA0104018 | Trimming, 100KΩ (B) | L301 | 1 | 1 | LS1029004 | MPX Coil, 56mH |
| R363 | 1 | 1 | RA0103025 | Trimming, 10KΩ (B) | L302 | 1 | 1 | LS1029004 | MPX Coil, 56mH |
| R364 | 1 | 1 | RT0522214 | 2.2KΩ | L303 | 1 | 1 | LS1029005 | MPX Coil, 56mH |
| R365 | 1 | 1 | RT0510114 | 100 Ω | L304 | 1 | 1 | LS1029005 | MPX Coil, 56mH |
| R366 | 1 | 1 | RT0510314 | 10K Ω | L305 | 1 | 1 | LC2105001 | Choke Coil, 1mH |
| R367 | 1 | 1 | RT0510114 | 100 Ω | J301 | 1 | 1 | YP1000113 | Plug |
| R368 | 1 | 1 | RT0527414 | 270K Ω | J322 | 1 | 1 | | |
| R369 | 1 | 1 | RT0510314 | 10KΩ | P300-SEMICONDUCTORS | | | | |
| R370 | 1 | 1 | RT0512314 | 12KΩ | H301 | 1 | 1 | HF200301C | FET, 2SK 30Y |
| R371 | 1 | 1 | RT0522114 | 220Ω | H302 | 1 | 1 | HT308281D | Transistor, 2SC 828S |
| R373 | 1 | 1 | RT0582314 | 82KΩ | H303 | 1 | 1 | HT308281D | Transistor, 2SC 828S |
| R374 | 1 | 1 | RA0103025 | Trimming, 10KΩ (B) | H304 | 1 | 1 | HT307322A | Transistor, 2SC 732 B or G |
| R375 | 1 | 1 | RT0510114 | 100Ω | H305 | 1 | 1 | HT307322A | Transistor, 2SC 732 B or G |
| R376 | 1 | 1 | RT0510414 | 100KΩ | H306 | 1 | 1 | HT104942A | Transistor, 2SA 494 G or Y |
| R377 | 1 | 1 | RT0510414 | 100KΩ | H307 | 1 | 1 | HT104942A | Transistor, 2SA 494 G or Y |
| R378 | 1 | 1 | RT0556214 | 5.6KΩ | H308 | 1 | 1 | HT308281D | Transistor, 2SC 828 S |
| R379 | 1 | 1 | RT0533214 | 3.3KΩ | H309 | 1 | 1 | HT308281D | Transistor, 2SC 828 S |
| P300-CAPACITORS | | | | | H310 | 1 | 1 | HT308281D | Transistor, 2SC 828 S |
| C301 | 1 | 1 | DF1633205 | Film, 3300PF ±10% | H311 | 1 | 1 | HT308281D | Transistor, 2SC 828 S |
| C302 | 1 | 1 | EA3360109 | Electroly, 33μF, 10V | H312 | 1 | 1 | HF200300A | FET, 2SK30Y |
| C303 | 1 | 1 | DF1722305 | Film, 0.022μF ±20% | H313 | 1 | 1 | HT308281D | Transistor, 2SC828S |
| C304 | 1 | 1 | EA2260169 | Electroly, 22μF, 16V | H314 | 1 | 1 | HT308281D | Transistor, 2SC828S |
| C305 | 1 | 1 | DF5547101 | Film, 470PF ±5% | H315 | 1 | 1 | HT308281D | Transistor, 2SC828S |
| C306 | 1 | 1 | EA2260169 | Electroly, 22μF, 16V | H316 | 1 | 1 | HT308281D | Transistor, 2SC828S |
| C307 | 1 | 1 | EQ4740501 | Electroly, 0.47μF ±20%, 50V | H317 | 1 | 1 | HT308281D | Transistor, 2SC828S |
| C308 | 1 | 1 | EQ2240501 | Electroly, 0.22μF ±20%, 50V | H318 | 1 | 1 | HD1000105 | Diode, IN60 |
| C309 | 1 | 1 | EQ2240501 | Electroly, 0.22μF ±20%, 50V | H319 | 1 | 1 | HD1000105 | Diode, IN60 |
| C310 | 1 | 1 | DF1747301 | Film, 0.047μF ±20% | H321 | 1 | 1 | HC1000401 | IC, HA1156 |
| C311 | 1 | 1 | DF1515205 | Film, 1500PF ±5% | PHONO AMP. CIRCUIT BOARD-P400 | | | | |
| C312 | 1 | 1 | DF1515205 | Film, 1500PF ±5% | P400 | 1 | 1 | YD2892008 | P. W. Board, Phono Amp.(Print Only) |
| C313 | 1 | 1 | DD1536101 | Ceramic, 360PF ±5% | | 1 | 1 | ZZ2892008 | P. W. Board Assembly |
| C314 | 1 | 1 | DD1536101 | Ceramic, 360PF ±5% | | | | | |
| C315 | 1 | 1 | DF1533205 | Film, 3300PF ±5% | | | | | |
| C316 | 1 | 1 | DF1533205 | Film, 3300PF ±5% | | | | | |
| C317 | 1 | 1 | DF1515205 | Film, 1500PF ±5% | | | | | |
| C318 | 1 | 1 | DF1515205 | Film, 1500PF ±5% | | | | | |
| C319 | 1 | 1 | DF1522205 | Film, 2200PF ±5% | | | | | |

| REF. DESIG. | U | E | PART NO. | DESCRIPTION |
|--|---|---|-----------|---------------------------|
| P400-RESISTORS | | | | |
| All resistors are ±5% and ¼W, unless otherwise indicated | | | | |
| R401 | 1 | 1 | RT0556314 | 56KΩ |
| R402 | 1 | 1 | RT0556314 | 56KΩ |
| R403 | 1 | 1 | RT0547114 | 470Ω |
| R404 | 1 | 1 | RT0547114 | 470Ω |
| R405 | 1 | 1 | RN0533314 | 33KΩ |
| R406 | 1 | 1 | RN0510514 | 1MΩ |
| R407 | 1 | 1 | RN0510514 | 1MΩ |
| R408 | 1 | 1 | RA0104018 | Trimming, 100KΩ ±30%(B) |
| R409 | 1 | 1 | RA0104018 | Trimming, 100KΩ ±30%(B) |
| R410 | 1 | 1 | RN0527314 | 27KΩ |
| R411 | 1 | 1 | RN0527314 | 27KΩ |
| R412 | 1 | 1 | RT0562114 | 620Ω |
| R413 | 1 | 1 | RT0562114 | 620Ω |
| R414 | 1 | 1 | RT0522514 | 2.2MΩ |
| R415 | 1 | 1 | RT0522514 | 2.2MΩ |
| R416 | 1 | 1 | RN0522514 | 2.2MΩ |
| R417 | 1 | 1 | RN0522514 | 2.2MΩ |
| R418 | 1 | 1 | RN0527414 | 270KΩ |
| R419 | 1 | 1 | RN0527414 | 270KΩ |
| R420 | 1 | 1 | RT0547314 | 47KΩ |
| R421 | 1 | 1 | RT0547314 | 47KΩ |
| R422 | 1 | 1 | RT0522214 | 2.2KΩ |
| R423 | 1 | 1 | RT0522214 | 2.2KΩ |
| R424 | 1 | 1 | RN0568414 | 680KΩ |
| R425 | 1 | 1 | RN0568414 | 680KΩ |
| R426 | 1 | 1 | RN0510414 | 100KΩ |
| R427 | 1 | 1 | RN0510414 | 100KΩ |
| R428 | 1 | 1 | RN0547314 | 47KΩ |
| R429 | 1 | 1 | RN0547314 | 47KΩ |
| R430 | 1 | 1 | RT0547014 | 47Ω |
| R431 | 1 | 1 | RT0547014 | 47Ω |
| R432 | 1 | 1 | RN0533214 | 3.3KΩ |
| R433 | 1 | 1 | RN0533214 | 3.3KΩ |
| R434 | 1 | 1 | RT0510114 | 100 Ω |
| R435 | 1 | 1 | RT0547014 | 47Ω |
| R436 | 1 | 1 | RT0547014 | 47Ω |
| P400-CAPACITORS | | | | |
| C401 | 1 | 1 | EV1050256 | Electroly, 1μF ±20%, 25V |
| C402 | 1 | 1 | EV1050256 | Electroly, 1μF ±20%, 25V |
| C403 | 1 | 1 | EE4760163 | Electroly, 47μF ±20%, 16V |
| C404 | 1 | 1 | EE4760163 | Electroly, 47μF ±20%, 16V |
| C405 | 1 | 1 | DD1540004 | Ceramic, 40PF ±5%, 50V |
| C406 | 1 | 1 | DD1540004 | Ceramic, 40PF ±5%, 50V |
| C407 | 1 | 1 | DD1104001 | Ceramic, 4PF ±0.5PF, 50V |
| C408 | 1 | 1 | DD1104001 | Ceramic, 4PF ±0.5PF, 50V |
| C409 | 1 | 1 | DF6556201 | Film, 5600PF±5%, 50V |
| C410 | 1 | 1 | DF6556201 | Film, 5600PF±5%, 50V |
| C411 | 1 | 1 | DF6516201 | Film, 1600PF±5%, 50V |
| C412 | 1 | 1 | DF6516201 | Film, 1600PF±5%, 50V |
| C413 | 1 | 1 | ED1070351 | Electroly, 100μF, 35V |
| C414 | 1 | 1 | DF1710552 | Film, 1μF ±20%, 250V |
| C415 | 1 | 1 | DF1710552 | Film, 1μF ±20%, 250V |
| C416 | 1 | 1 | DD1650001 | Ceramic, 50PF ±10%, 250V |
| C417 | 1 | 1 | DD1650001 | Ceramic, 50PF ±10%, 250V |
| P400-SEMICONDUCTORS & PLUGS | | | | |
| H401 | 1 | 1 | HT313441E | Transistor, 2SC1344E |
| H402 | 1 | 1 | HT313441E | Transistor, 2SC1344E |
| H403 | 1 | 1 | HT313442A | Transistor, 2SC1344D,E |
| H404 | 1 | 1 | HT313442A | Transistor, 2SC1344D, E |
| H405 | 1 | 1 | HT304580R | Transistor, 2SC458L, B |
| H406 | 1 | 1 | HT304580R | Transistor, 2SC458L, B |

| REF. DESIG. | U | E | PART NO. | DESCRIPTION |
|---|---|---|-----------|---------------------------------|
| H407 | 1 | 1 | HD2000121 | Diode, IS-2473CYe |
| H408 | 1 | 1 | HD2000121 | Diode, IS-2473CYe |
| H409 | 1 | 1 | HV0000206 | Varistor, VD1212 |
| J401 | 1 | 1 | YP1000113 | Plug |
| J402 | 1 | 1 | YP1000113 | Plug |
| J403 | 1 | 1 | YP1000113 | Plug |
| J404 | 1 | 1 | YP1000113 | Plug |
| J405 | 1 | 1 | YP1000113 | Plug |
| J406 | 1 | 1 | YP1000113 | Plug |
| J407 | 1 | 1 | YP1000113 | Plug |
| J408 | 1 | 1 | YP1000113 | Plug |
| DOLBY CIRCUIT BOARD-P600 | | | | |
| P600 | 1 | 1 | YD2886008 | P. W. Board, Dolby (Print Only) |
| | | | ZZ2918108 | P. W. Board Assembly |
| P600-RESISTORS | | | | |
| All resistors are ±5% and W¼, unless otherwise indicated. | | | | |
| R601 | 1 | 1 | RT0547414 | 470KΩ |
| R602 | 1 | 1 | RT0547414 | 470KΩ |
| R603 | 1 | 1 | RT0510414 | 100KΩ |
| R604 | 1 | 1 | RT0510414 | 100KΩ |
| R605 | 1 | 1 | RT0533214 | 3.3KΩ |
| R606 | 1 | 1 | RT0533214 | 3.3KΩ |
| R607 | 1 | 1 | RT0510214 | 1KΩ |
| R608 | 1 | 1 | RT0510214 | 1KΩ |
| R609 | 1 | 1 | RT0539314 | 39KΩ |
| R610 | 1 | 1 | RT0539314 | 39KΩ |
| R611 | 1 | 1 | RT0568214 | 6.8KΩ |
| R612 | 1 | 1 | RT0568214 | 6.8KΩ |
| R613 | 1 | 1 | RT0510114 | 100Ω |
| R614 | 1 | 1 | RT0510114 | 100Ω |
| R615 | 1 | 1 | RT0522214 | 2.2KΩ |
| R616 | 1 | 1 | RT0522214 | 2.2KΩ |
| R617 | 1 | 1 | RT0512114 | 120Ω |
| R618 | 1 | 1 | RT0512114 | 120Ω |
| R619 | 1 | 1 | RT0556114 | 560Ω |
| R620 | 1 | 1 | RT0556114 | 250Ω |
| R621 | 1 | 1 | RT0533314 | 33KΩ |
| R622 | 1 | 1 | RT0533314 | 33KΩ |
| R623 | 1 | 1 | RT0215414 | 150KΩ ±2%, ¼W |
| R624 | 1 | 1 | RT0215414 | 150KΩ ±2%, ¼W |
| R625 | 1 | 1 | RT0218414 | 180KΩ ±2%, ¼W |
| R626 | 1 | 1 | RT0218414 | 180KΩ ±2%, ¼W |
| R627 | 1 | 1 | RT0527314 | 27KΩ |
| R628 | 1 | 1 | RT0527314 | 27KΩ |
| R629 | 1 | 1 | RT0582214 | 8.2KΩ |
| R630 | 1 | 1 | RT0582214 | 8.2KΩ |
| R631 | 1 | 1 | RT0215414 | 150KΩ ±2%, ¼W |
| R632 | 1 | 1 | RT0215414 | 150KΩ ±2%, ¼W |
| R633 | 1 | 1 | RT0522314 | 22KΩ |
| R634 | 1 | 1 | RT0522314 | 22KΩ |
| R635 | 1 | 1 | RT0227214 | 2.7KΩ ±2%, ¼W |
| R636 | 1 | 1 | RT0227214 | 2.7KΩ ±2%, ¼W |
| R637 | 1 | 1 | RT0533314 | 33KΩ |
| R638 | 1 | 1 | RT0533314 | 33KΩ |
| R639 | 1 | 1 | RT0547314 | 47KΩ |
| R640 | 1 | 1 | RT0547314 | 47KΩ |
| R643 | 1 | 1 | RT0527414 | 270KΩ |
| R644 | 1 | 1 | RT0527414 | 270KΩ |

| REF. DESIG. | U | E | PART NO. | DESCRIPTION |
|------------------------|---|---|-----------|--|
| R645 | 1 | 1 | RT0547314 | 47K Ω |
| R646 | 1 | 1 | RT0547314 | 47K Ω |
| R647 | 1 | 1 | RT0533214 | 3.3K Ω |
| R648 | 1 | 1 | RT0533214 | 3.3K Ω |
| R649 | 1 | 1 | RT0515214 | 1.5K Ω |
| R650 | 1 | 1 | RT0515214 | 1.5K Ω |
| R651 | 1 | 1 | RT0518314 | 18K Ω |
| R652 | 1 | 1 | RT0518314 | 18K Ω |
| R653 | 1 | 1 | RA0103022 | Variable, 10K Ω (B) |
| R654 | 1 | 1 | RA0103022 | Variable, 10K Ω (B) |
| R655 | 1 | 1 | RT0527214 | 2.7K Ω |
| R656 | 1 | 1 | RT0527214 | 2.7K Ω |
| R657 | 1 | 1 | RT0568414 | 680K Ω |
| R658 | 1 | 1 | RT0568414 | 680K Ω |
| R659 | 1 | 1 | RA0102020 | Variable, 1K Ω (B) |
| R660 | 1 | 1 | RA0102020 | Variable, 1K Ω (B) |
| R661 | 1 | 1 | RT0515314 | 15K Ω |
| R662 | 1 | 1 | RT0515314 | 15K Ω |
| R663 | 1 | 1 | RT0582214 | 8.2K Ω |
| R664 | 1 | 1 | RT0582214 | 8.2K Ω |
| R665 | 1 | 1 | RT0510314 | 10K Ω |
| R666 | 1 | 1 | RT0510314 | 10K Ω |
| R667 | 1 | 1 | RT0582214 | 8.2K Ω |
| R668 | 1 | 1 | RT0582214 | 8.2K Ω |
| R669 | 1 | 1 | RT0582214 | 8.2K Ω |
| R670 | 1 | 1 | RT0582214 | 8.2K Ω |
| R671 | 1 | 1 | RT0533314 | 33K Ω |
| R672 | 1 | 1 | RT0533314 | 33K Ω |
| R673 | 1 | 1 | RT0512414 | 120K Ω |
| R674 | 1 | 1 | RT0512414 | 120K Ω |
| R675 | 1 | 1 | RT0547314 | 47K Ω |
| R676 | 1 | 1 | RT0547314 | 47K Ω |
| R677 | 1 | 1 | RT0527214 | 2.7K Ω |
| R678 | 1 | 1 | RT0527214 | 2.7K Ω |
| R679 | 1 | 1 | RT0510214 | 1K Ω |
| R680 | 1 | 1 | RT0510214 | 1K Ω |
| R681 | 1 | 1 | RT0533014 | 33 Ω |
| R682 | 1 | 1 | RT0533014 | 33 Ω |
| R683 | 1 | 1 | RT0547014 | 47 Ω |
| R684 | 1 | 1 | RT0547014 | 47 Ω |
| R685 | 1 | 1 | RT0515314 | 15K Ω |
| R686 | 1 | 1 | RT0515314 | 15K Ω |
| R687 | 1 | 1 | RT0527414 | 270K Ω |
| R688 | 1 | 1 | RT0527414 | 270K Ω |
| R689 | 1 | 1 | RT0527414 | 270K Ω |
| R690 | 1 | 1 | RT0527414 | 270K Ω |
| R691 | 1 | 1 | RT0522414 | 220K Ω |
| R692 | 1 | 1 | RT0522414 | 220K Ω |
| R693 | 1 | 1 | RC1010112 | 100 Ω $\pm 10\%$, $\frac{1}{2}W$ |
| P600-CAPACITORS | | | | |
| C601 | 1 | 1 | EE3350251 | Electroly, 3.3 μF , 25V |
| C602 | 1 | 1 | EE3350251 | Electroly, 3.3 μF , 25V |
| C603 | 1 | 1 | DF6610101 | Film, 100PF $\pm 10\%$ |
| C604 | 1 | 1 | DF6610101 | Film, 100PF $\pm 10\%$ |
| C605 | 1 | 1 | DF1510205 | Film, 1000PF $\pm 5\%$ |
| C606 | 1 | 1 | DF1510205 | Film, 1000PF $\pm 5\%$ |
| C607 | 1 | 1 | EA1060169 | Electroly, 10 μF , 16V |
| C608 | 1 | 1 | EA1060169 | Electroly, 10 μF , 16V |
| C609 | 1 | 1 | EA1060169 | Electroly, 10 μF , 16V |
| C610 | 1 | 1 | EA1060169 | Electroly, 10 μF , 16V |
| C611 | 1 | 1 | EA1060169 | Electroly, 10 μF , 16V |
| C612 | 1 | 1 | EA1060169 | Electroly, 10 μF , 16V |

| REF. DESIG. | U | E | PART NO. | DESCRIPTION |
|-------------------------------|---|---|-----------|-------------------------------|
| C613 | 1 | 1 | EA1060169 | Electroly, 10 μF , 16V |
| C614 | 1 | 1 | EA1060169 | Electroly, 10 μF , 16V |
| C617 | 1 | 1 | DF1556205 | Film, 5600PF $\pm 5\%$ |
| C618 | 1 | 1 | DF1556205 | Film, 5600PF $\pm 5\%$ |
| C619 | 1 | 1 | DF1527305 | Film, 0.027 μF $\pm 5\%$ |
| C620 | 1 | 1 | DF1527305 | Film, 0.027 μF $\pm 5\%$ |
| C621 | 1 | 1 | DF1547205 | Film, 4700PF $\pm 5\%$ |
| C622 | 1 | 1 | DF1547205 | Film, 4700PF $\pm 5\%$ |
| C623 | 1 | 1 | EA1060169 | Electroly, 10 μF , 16V |
| C624 | 1 | 1 | EA1060169 | Electroly, 10 μF , 16V |
| C625 | 1 | 1 | DF1610405 | Film, 0.1 μF $\pm 10\%$ |
| C626 | 1 | 1 | DF1610405 | Film, 0.1 μF $\pm 10\%$ |
| C627 | 1 | 1 | EA4760109 | Electroly, 47 μF , 10V |
| C628 | 1 | 1 | EA4760109 | Electroly, 47 μF , 10V |
| C629 | 1 | 1 | DF1610405 | Film, 0.1 μF $\pm 10\%$ |
| C630 | 1 | 1 | DF1610405 | Film, 0.1 μF $\pm 10\%$ |
| C631 | 1 | 1 | EA1060169 | Electroly, 10 μF , 16V |
| C632 | 1 | 1 | EA1060169 | Electroly, 10 μF , 16V |
| C633 | 1 | 1 | DF1610405 | Film, 0.1 μF $\pm 10\%$ |
| C634 | 1 | 1 | DF1610405 | Film, 0.1 μF $\pm 10\%$ |
| C635 | 1 | 1 | EA1060169 | Electroly, 10 μF , 16V |
| C636 | 1 | 1 | EA1060169 | Electroly, 10 μF , 16V |
| C637 | 1 | 1 | DF1610405 | Film, 0.1 μF $\pm 10\%$ |
| C638 | 1 | 1 | DF1610405 | Film, 0.1 μF $\pm 10\%$ |
| C639 | 1 | 1 | DF1633405 | Film, 0.33 μF $\pm 10\%$ |
| C640 | 1 | 1 | DF1633405 | Film, 0.33 μF $\pm 10\%$ |
| C641 | 1 | 1 | EA2270259 | Electroly, 220 μF , 25V |
| P600-COILS & PLUGS | | | | |
| L601 | 1 | 1 | LC2226004 | Choke Coil, 22mH |
| L602 | 1 | 1 | LC2226004 | Choke Coil, 22mH |
| J601 | ? | 1 | YP1000109 | Plug |
| J608 | ? | 1 | YP1000109 | Plug |
| J611 | 1 | 1 | YP1000109 | Plug |
| J612 | 1 | 1 | YP1000109 | Plug |
| J615 | ? | 1 | YP1000109 | Plug |
| J621 | ? | 1 | YP1000109 | Plug |
| P600-SEMICONDUCTORS | | | | |
| H601 | 1 | 1 | HT313271T | Transistor, 2SC1327 T,U |
| H602 | 1 | 1 | HT313271T | Transistor, 2SC1327 T,U |
| H603 | 1 | 1 | HT306441B | Transistor, 2SC644S |
| H604 | 1 | 1 | HT306441B | Transistor, 2SC644S |
| H605 | 1 | 1 | HT104941C | Transistor, 2SA494Y |
| H606 | 1 | 1 | HT104941C | Transistor, 2SA494Y |
| H607 | 1 | 1 | HT306441B | Transistor, 2SC644S |
| H608 | 1 | 1 | HT306441B | Transistor, 2SC644S |
| H609 | 1 | 1 | HT306441B | Transistor, 2SC644S |
| H610 | 1 | 1 | HT306441B | Transistor, 2SC644S |
| H611 | 1 | 1 | HF200301E | Transistor, 2SK30D |
| H612 | 1 | 1 | HF200301E | Transistor, 2SK30D |
| H613 | 1 | 1 | HT306441B | Transistor, 2SC644S |
| H614 | 1 | 1 | HT306441B | Transistor, 2SC644S |
| H615 | 1 | 1 | HT104941C | Transistor, 2SA494Y |
| H616 | 1 | 1 | HT104941C | Transistor, 2SA494Y |
| H617 | 1 | 1 | HT306441B | Transistor, 2SC644S |
| H618 | 1 | 1 | HT306441B | Transistor, 2SC644S |
| H621 | 1 | 1 | HD1000105 | Diode, IN60 |
| H622 | 1 | 1 | HD1000105 | Diode, IN60 |
| H623 | 1 | 1 | HD2000121 | Diode, IS2473 |
| H624 | 1 | 1 | HD2000121 | Diode, IS2473 |
| H625 | 1 | 1 | HD3003109 | Diode, WZ-081 |

| REF. DESIG. | U | E | PART NO. | DESCRIPTION |
|---|----|----|-----------|-------------------------------------|
| H626 | 1 | 1 | HD2000121 | IS2473 |
| H627 | 1 | 1 | HD2000121 | IS2473 |
| H628 | 1 | 1 | HD2000121 | IS2473 |
| H629 | 1 | 1 | HD2000121 | IS2473 |
| P600-MISCELLANEOUS | | | | |
| 2023 | 1 | 1 | 288616003 | Bracket |
| 2024 | 2 | 2 | 288616004 | Bracket |
| 2025 | 4 | 4 | 515703058 | P. H. Tapt Screw P 3 x 5ST |
| 2026 | 2 | 2 | 54050300R | T. L. Washer OR |
| 2027 | 4 | 4 | 51100304S | B. H. M. Screw B 3 x 4 |
| GENERAL MISCELLANEOUS | | | | |
| 1909 | 8 | 8 | 51100306S | B. H. M. Screw B 3x6 |
| 1910 | 2 | 2 | 51102605S | B. H. M. Screw B 2.6x5 |
| 1912 | 2 | 2 | 291810402 | Retainer |
| 1913 | 2 | 2 | 291812003 | Insulator |
| 1914 | 4 | 4 | 51102605S | B. H. M. Screw B 2.6x5 |
| H001 | 1 | 1 | HT107470A | Transistor, 2SA747A R or O |
| H002 | 1 | 1 | HT107470A | Transistor, 2SA747A R or O |
| H003 | 1 | 1 | HT311160A | Transistor, 2SC116A R or O |
| H004 | 1 | 1 | HT311160A | Transistor, 2SC116A R or O |
| H005 | 1 | 1 | HT107470A | Transistor, 2SA747A R or O |
| H006 | 1 | 1 | HT107470A | Transistor, 2SA747A R or O |
| H007 | 1 | 1 | HT311160A | Transistor, 2SC116A R or O |
| H008 | 1 | 1 | HT311160A | Transistor, 2SC116A R or O |
| J020 | 1 | 1 | YJ0500019 | Socket, Transistor |
| J021 | 1 | 1 | YJ0500019 | Socket, Transistor |
| J022 | 1 | 1 | YJ0500019 | Socket, Transistor |
| J023 | 1 | 1 | YJ0500019 | Socket, Transistor |
| J024 | 1 | 1 | YJ0500019 | Socket, Transistor |
| J025 | 1 | 1 | YJ0500019 | Socket, Transistor |
| J026 | 1 | 1 | YJ0500019 | Socket, Transistor |
| J027 | 1 | 1 | YJ0500019 | Socket, Transistor |
| 1903 | 2 | 2 | 291826701 | Heat Sink |
| 1904 | 16 | 16 | 54040302N | Spring Washer |
| 1905 | 16 | 16 | 51100316B | B. H. M. Screw B 3 x 16 |
| 1906 | 4 | 4 | 291816003 | Bracket |
| 1907 | 8 | 8 | 51380306T | P. H. Tap Screw P 3 x 6 ST |
| 1917 | 4 | 4 | 291810401 | Retainer |
| 1918 | 8 | 8 | 51380306T | P. H. Tap Screw P 3 x 6 ST |
| POWER AMP. CIRCUIT BOARD-P700 | | | | |
| P700 | 2 | 2 | YD2918001 | P. W. Board, Power Amp.(Print Only) |
| | 2 | 2 | ZZ2918001 | P. W. Board Assembly |
| P700-RESISTORS All resistors are ±5% and ¼W, unless otherwise indicated. | | | | |
| R701 | 2 | 2 | RT0547414 | 470KΩ |
| R702 | 2 | 2 | RT0510214 | 1KΩ |
| R703 | 2 | 2 | RT0510414 | 100KΩ |
| R704 | 2 | 2 | RT0510314 | 10KΩ |
| R705 | 2 | 2 | RT0591314 | 91KΩ |
| R706 | 2 | 2 | RT0547114 | 470Ω |
| R707 | 2 | 2 | RT0515114 | 150Ω |
| R708 | 2 | 2 | RT0575214 | 7.5KΩ |
| R709 | 2 | 2 | RT0233214 | 3.3KΩ ±2%, ¼W |
| R710 | 2 | 2 | RT0522414 | 220KΩ |
| R711 | 2 | 2 | GM0282212 | 8.2KΩ ±2%, ¼W |
| R712 | 2 | 2 | GU0510312 | 10KΩ ±5%, ¼W |
| R713 | 2 | 2 | RA0102023 | Trimming, 1KΩ (B) |

| REF. DESIG. | U | E | PART NO. | DESCRIPTION |
|-----------------------------------|---|---|-----------|-------------------------------|
| R714 | 2 | 2 | RT0520214 | 2KΩ |
| R715 | 2 | 2 | RT0582214 | 8.2KΩ |
| R716 | 2 | 2 | RT0568114 | 680Ω |
| R717 | 2 | 2 | RT0522114 | 220Ω |
| R718 | 2 | 2 | RT0527014 | 27Ω |
| R719 | 2 | 2 | GJ0512202 | 1.2KΩ ±5%, 2W |
| R720 | 2 | 2 | GJ0512202 | 1.2KΩ ±5%, 2W |
| R721 | 2 | 2 | RT0527114 | 270Ω |
| R722 | 2 | 2 | RT0527314 | 27KΩ |
| R723 | 2 | 2 | RT0527314 | 27KΩ |
| R724 | 2 | 2 | GD0556114 | 560Ω |
| R725 | 2 | 2 | GD0556114 | 560Ω |
| R726 | 2 | 2 | RT0510114 | 100Ω |
| R727 | 2 | 2 | RT0510114 | 100Ω |
| R728 | 2 | 2 | RT0547314 | 47KΩ |
| R729 | 2 | 2 | RT0210414 | 100KΩ ±2%, ¼W |
| R730 | 2 | 2 | RC0000012 | 0Ω, ¼W |
| R731 | 2 | 2 | RC0000012 | 0Ω, ¼W |
| R732 | 2 | 2 | GF0562014 | 62Ω |
| R733 | 2 | 2 | GF0562014 | 62Ω |
| R734 | 2 | 2 | HH0000703 | SDT-100 1KΩ/25°C |
| R735 | 2 | 2 | HH0000703 | SDT-100 1KΩ/25°C |
| R736 | 2 | 2 | GF0547214 | 4.7KΩ |
| R737 | 2 | 2 | GF0547214 | 4.7KΩ |
| R738 | 2 | 2 | GD0524214 | 2.4KΩ |
| R739 | 2 | 2 | RT0504714 | 4.7Ω |
| R740 | 2 | 2 | RA0102023 | Trimming, 1KΩ (B) |
| R741 | 2 | 2 | GJ0547001 | 47Ω ±5%, 1W |
| R742 | 2 | 2 | GJ0547001 | 47Ω ±5%, 1W |
| R743 | 2 | 2 | GJ0501501 | 1.5Ω ±5%, 1W |
| R744 | 2 | 2 | GJ0501501 | 1.5Ω ±5%, 1W |
| R745 | 2 | 2 | RT0504714 | 4.7Ω |
| R746 | 2 | 2 | GJ0522003 | 22Ω ±5%, 3W |
| R747 | 2 | 2 | GJ0502202 | 2.2Ω ±5%, 2W |
| R748 | 2 | 2 | BX1010201 | (0.1Ω+0.1Ω)±10%, 5W |
| R749 | 2 | 2 | BX1020201 | (0.2Ω+0.2Ω)±10%, 5W |
| R750 | 2 | 2 | BX1020201 | (0.2Ω+0.2Ω)±10%, 5W |
| R753 | 2 | 2 | RC0000012 | 0Ω, ¼W |
| R754 | 2 | 2 | RC0000012 | 0Ω, ¼W |
| P700-CAPACITORS & COIL | | | | |
| C701 | 2 | 2 | DF1710552 | Film, 1μF ±20%, 250V |
| C702 | 2 | 2 | DD1510101 | Ceramic, 100PF ±5%, 50V |
| C703 | 2 | 2 | EV3360066 | Electroly, 33μF ±20%, 6.3V |
| C704 | 2 | 2 | DK1610251 | Ceramic, 1000PF ±10%, 500V |
| C705 | 2 | 2 | DK1610251 | Ceramic, 1000PF ±10%, 500V |
| C706 | 2 | 2 | EA1060259 | Electroly, 10μF+50%,-10%, 25V |
| C707 | 2 | 2 | EA1060259 | Electroly, 10μF+50%,-10%, 25V |
| C708 | 2 | 2 | DF1710453 | Film, 0.1μF ±20%, 250V |
| C709 | 2 | 2 | DF1710453 | Film, 0.1μF ±20%, 250V |
| C710 | 2 | 2 | DK1610150 | Ceramic, 100PF ±10%, 500V |
| C711 | 2 | 2 | DD1008050 | Ceramic, 8PF ±0.25PF, 500V |
| C712 | 2 | 2 | DK1610150 | Ceramic, 100PF ±10%, 500V |
| C713 | 2 | 2 | DK1610150 | Ceramic, 100PF ±10%, 500V |
| C714 | 2 | 2 | DF1710453 | Film, 0.1μF ±20%, 250V |
| C715 | 2 | 2 | DF1747301 | Film, 0.047μF±20%, 50V |
| C716 | 2 | 2 | DF1747301 | Film, 0.047μF±20%, 50V |
| C718 | 2 | 2 | DK1610251 | Ceramic, 1000PF ±10%, 500V |
| C719 | 2 | 2 | DF1733350 | Film, 0.033μF±20%, 250V |
| C721 | 2 | 2 | DF1710453 | Film, 0.1μF ±20%, 250V |
| C722 | 2 | 2 | DF1710351 | Film, 0.01μF ±20%, 200V |
| L701 | 2 | 2 | LC2222001 | Choke Coil, 2.2μH ±10% |

U U.S.A.
E Europe

| REF. DESIG. | U | E | PART NO. | DESCRIPTION |
|--|---|---|-----------|--|
| P700-SEMICONDUCTORS, JACK & PLUGS | | | | |
| H701 | 1 | 1 | HT107221S | Transistor, 2SA722 S, T |
| H702 | 1 | 1 | HT107221S | Transistor, 2SA722 S, T |
| H703 | 2 | 2 | HT107223A | Transistor, 2SA722 S,T,U |
| H704 | 2 | 2 | HT107202A | Transistor, 2SA720 R,S |
| H705 | 2 | 2 | HT313182R | Transistor, 2SC1318 R,S |
| H706 | 1 | 1 | HT108181D | Transistor, 2SA818 |
| H707 | 1 | 1 | HT316281D | Transistor, 2SC1628 |
| H708 | 1 | 1 | HT316691B | Transistor, 2SC1669 |
| H709 | 1 | 1 | HT108391B | Transistor, 2SA839 |
| H710 | 2 | 2 | HT309452A | Transistor, 2SC945 Q, R |
| H711 | 2 | 2 | HT107332A | Transistor, 2SA733 P, Q |
| H712 | 2 | 2 | HT107332A | Transistor, 2SA733 P, Q |
| H713 | 2 | 2 | HT309452A | Transistor, 2SC945 Q, R |
| H714 | 2 | 2 | HT304961B | Transistor, 2SC496 O |
| H715 | 2 | 2 | HT304961B | Transistor, 2SC496 O |
| H716 | 2 | 2 | HD3004409 | Diode, CZ-205 |
| H717 | 2 | 2 | HD3004409 | Diode, CZ-205 |
| H718 | 2 | 2 | HV0000506 | Varistor, VD1122 |
| H719 | 2 | 2 | HV0000506 | Varistor, VD1122 |
| H720 | 2 | 2 | HD2000321 | Diode, IS2471 (Black) |
| H721 | 2 | 2 | HD2000321 | Diode IS2471 (Black) |
| J701 | 2 | 2 | YJ0600029 | Jack |
| J702 | 2 | 2 | YP1000099 | Plug |
| J703 | 2 | 2 | YP1000099 | Plug |
| J704 | 2 | 2 | YP1000099 | Plug |
| J705 | 2 | 2 | YP1000099 | Plug |
| J706 | 2 | 2 | YP1000099 | Plug |
| J707 | 2 | 2 | YP1000099 | Plug |
| J708 | 2 | 2 | YP1000099 | Plug |
| J709 | 2 | 2 | YP1000099 | Plug |
| J710 | 2 | 2 | YP0600045 | Plug |
| GENERAL MISCELLANEOUS | | | | |
| 1803 | 4 | 4 | 291826703 | Heat Sink |
| 1805 | 8 | 8 | 51100310E | B. H. M. Screw B 3 x 10 |
| 1806 | 8 | 8 | 54040302N | Spring Washer |
| 1807 | 8 | 8 | 53110302E | Hexagon Nut |
| 1812 | 8 | 8 | 53110303E | Hexagon Nut |
| 1813 | 8 | 8 | 54050300R | T. L. Washer OR |
| 1818 | 2 | 2 | 291826706 | Heat Sink |
| 1819 | 4 | 4 | 291811801 | Spacer |
| 1820 | 4 | 4 | 51100310E | B. H. M. Screw B 3 x 10 |
| 1821 | 4 | 4 | 53110303E | Hexagon Nut |
| 1823 | 4 | 4 | 53110303E | Hexagon Nut |
| 1824 | 4 | 4 | 54050300R | T. L. Washer OR |
| 1828 | 2 | 2 | 291826705 | Heat Sink |
| 1830 | 2 | 2 | 51102610E | B. H. M. Screw B 2.6 x 10 |
| 1831 | 2 | 2 | 53112603E | Hexagon Nut |
| 1832 | 2 | 2 | 54042602N | Spring Washer |
| 1703 | 1 | 1 | 291826702 | Heat Sink |
| 1705 | 2 | 2 | 51100306S | B. H. M. Screw B 3 x 6 |
| 1707 | 2 | 2 | 51100310E | B. H. M. Screw B 3 x 10 |
| 1708 | 2 | 2 | 53110303E | Hexagon Nut |
| 1709 | 2 | 2 | 54050300R | T. L. Washer OR |
| POWER SUPPLY CIRCUIT BOARD-P800 | | | | |
| P800 | 1 | 1 | YD2918004 | P. W. Board, Power Supply (Print Only) |
| | 1 | 1 | ZZ2918004 | P. W. Board Assembly |
| P800-RESISTORS | | | | |
| R801 | 1 | 1 | GQ1015105 | 150Ω ±10%, 5W |
| R802 | 1 | 1 | GF0533214 | 3.3KΩ ±5%, ¼W |
| R803 | 1 | 1 | GF0510014 | 10Ω ±5%, ¼W |
| R804 | 1 | 1 | GF0510012 | 10Ω ±5%, ½W |
| R805 | 1 | 1 | RT0547214 | 4.7KΩ ±5%, ¼W |
| R806 | 1 | 1 | RT0547214 | 4.7KΩ ±5%, ¼W |
| R807 | 1 | 1 | GF0539214 | 3.9KΩ ±5%, ¼W |
| R808 | 1 | 1 | RT0522314 | 22KΩ ±5%, ¼W |
| R809 | 1 | 1 | RA0502020 | Trimming, 5K Ω (B) |
| R810 | 1 | 1 | RT0556214 | 5.6KΩ ±5%, ¼W |
| R811 | 1 | 1 | GJ0527102 | 270Ω ±5%, 2W |
| R812 | 1 | 1 | RT0547214 | 4.7KΩ ±5%, ¼W |
| R813 | 1 | 1 | RT0527314 | 27KΩ ±5%, ¼W |
| R814 | 1 | 1 | RT0539314 | 39KΩ ±5%, ¼W |
| R815 | 1 | 1 | RT0539314 | 39KΩ ±5%, ¼W |
| R816 | 1 | 1 | RT0539414 | 390KΩ ±5%, ¼W |
| R817 | 1 | 1 | GJ0547101 | 470Ω ±5%, 1W |
| R818 | 1 | 1 | RC0000012 | 0Ω, ¼W |
| R819 | 1 | 1 | GU0556212 | 5.6KΩ ±5%, ¼W |
| R820 | 1 | 1 | GU0556212 | 5.6KΩ ±5%, ¼W |
| P800-CAPACITORS | | | | |
| C801 | 1 | 1 | DK1810351 | Ceramic, 0.01μ F+100%,-0%, 500V |
| C802 | 1 | 1 | DK1810351 | Ceramic, 0.01μ F+100%,-0%, 500V |
| C803 | 1 | 1 | EA4770631 | Electroly, 470μF, 63V |
| C804 | 1 | 1 | EA2270631 | Electroly, 220μF, 63V |
| C805 | 1 | 1 | EA4770169 | Electroly, 470μF, 16V |
| C806 | 1 | 1 | EA2270631 | Electroly, 220μF, 63V |
| C807 | 1 | 1 | EA3370509 | Electroly, 330μF, 50V |
| C808 | 1 | 1 | DF1747305 | Film, 0.047μF, 50V |
| C809 | 1 | 1 | EA1060509 | Electroly, 10μF, 50V |
| C810 | 1 | 1 | DF1710305 | Film, 0.01μF, 50V |
| C811 | 1 | 1 | EA1060639 | Electroly, 10μF, 63V |
| C812 | 1 | 1 | EA4760169 | Electroly, 47μF, 16V |
| C813 | 1 | 1 | EA2270109 | Electroly, 220μF, 10V |
| P800-SEMICONDUCTORS | | | | |
| H801 | 1 | 1 | HT403314A | Transistor, 2SD331 C.D.E.F |
| H802 | 1 | 1 | HT403314A | Transistor, 2SD331 C.D.E.F. |
| H803 | 1 | 1 | HT307343A | Transistor, 2SC734 R.O.Y |
| H804 | 1 | 1 | HT309452A | Transistor, 2SC945 Q.R |
| H805 | 1 | 1 | HT309452A | Transistor, 2SC945 Q.R |
| H806 | 1 | 1 | HT313183A | Transistor, 2SC1318 P.Q.R |
| H807 | 1 | 1 | HT313183A | Transistor, 2SC1318 P.Q.R |
| H808 | 1 | 1 | HD2001103 | Rectifier DS-131B |
| H809 | 1 | 1 | HD2001103 | Rectifier, DS-131B |
| H810 | 1 | 1 | HD3002709 | Diode, WZ-140 |
| H811 | 1 | 1 | HD3002309 | Diode, WZ-071 |
| H812 | 1 | 1 | HD2000321 | Diode, 1S2471 (Black) |
| P800-MISCELLANEOUS | | | | |
| L801 | 1 | 1 | LY2024007 | Relay, 24V, 10A |
| F801 | 1 | 1 | FS1002006 | Fuse, 0.2A |
| J801 | 1 | 1 | YP1000113 | Plug |
| J811 | 1 | 1 | YJ0800021 | Socket |
| J812 | 1 | 1 | YJ0800021 | Socket |
| J813 | 1 | 1 | YJ0800021 | Socket |
| PRE-TONE AMP. CIRCUIT BOARD PE01 | | | | |
| PE01 | 1 | 1 | YD2918002 | P.W.Board, Pre-Tone Amp. (Print Only) |
| | 1 | 1 | ZZ2918002 | P.W.Board Assembly |

| REF. DESIG. | U | E | PART NO. | DESCRIPTION |
|---|---|---|-----------|--|
| PE01-RESISTORS All resistors are $\pm 5\%$ and $\frac{1}{4}W$, unless otherwise indicated. | | | | |
| RE01 | 1 | 1 | RM0503061 | Variable, 50K Ω (B) |
| RE02 | 1 | 1 | RD0204001 | Variable, 200K Ω (B) |
| RE03 | 1 | 1 | RD0204001 | Variable, 200K Ω (B) |
| RE04 | 1 | 1 | RD0204001 | Variable, 200K Ω (B) |
| RE05 | 1 | 1 | RT0522314 | 22K Ω |
| RE06 | 1 | 1 | RT0522314 | 22K Ω |
| RE07 | 1 | 1 | RT0539214 | 3.9K Ω |
| RE08 | 1 | 1 | RT0539214 | 3.9K Ω |
| RE09 | 1 | 1 | RT0539114 | 390 Ω |
| RE10 | 1 | 1 | RT0539114 | 390 Ω |
| RE11 | 1 | 1 | RN0515414 | 150K Ω |
| RE12 | 1 | 1 | RN0515414 | 150K Ω |
| RE13 | 1 | 1 | RN0547414 | 470K Ω |
| RE14 | 1 | 1 | RN0547414 | 470K Ω |
| RE15 | 1 | 1 | RT0291114 | 910 Ω $\pm 2\%$, $\frac{1}{4}W$ |
| RE16 | 1 | 1 | RT0291114 | 910 Ω $\pm 2\%$, $\frac{1}{4}W$ |
| RE17 | 1 | 1 | RT0251214 | 5.1K Ω $\pm 2\%$, $\frac{1}{4}W$ |
| RE18 | 1 | 1 | RT0251214 | 5.1K Ω $\pm 2\%$, $\frac{1}{4}W$ |
| RE19 | 1 | 1 | RT0522414 | 220K Ω |
| RE20 | 1 | 1 | RT0522414 | 220K Ω |
| RE21 | 1 | 1 | RC0000012 | 0 Ω , $\frac{1}{4}W$ |
| RE22 | 1 | 1 | RC0000012 | 0 Ω , $\frac{1}{4}W$ |
| RE23 | 1 | 1 | RT0527314 | 27K Ω |
| RE24 | 1 | 1 | RT0527314 | 27K Ω |
| RE25 | 1 | 1 | RT0527314 | 27K Ω |
| RE26 | 1 | 1 | RT0527314 | 27K Ω |
| RE29 | 1 | 1 | RT0527314 | 27K Ω |
| RE30 | 1 | 1 | RT0527314 | 27K Ω |
| RE31 | 1 | 1 | RT0520314 | 20K Ω |
| RE32 | 1 | 1 | RT0520314 | 20K Ω |
| RE33 | 1 | 1 | RT0510314 | 10K Ω |
| RE34 | 1 | 1 | RT0510314 | 10K Ω |
| RE35 | 1 | 1 | RT0510314 | 10K Ω |
| RE36 | 1 | 1 | RT0510314 | 10K Ω |
| RE37 | 1 | 1 | RT0510314 | 10K Ω |
| RE38 | 1 | 1 | RT0510314 | 10K Ω |
| RE39 | 1 | 1 | RT0510314 | 10K Ω |
| RE40 | 1 | 1 | RT0510314 | 10K Ω |
| RE41 | 1 | 1 | RT0568414 | 680K Ω |
| RE42 | 1 | 1 | RT0568414 | 680K Ω |
| RE43 | 1 | 1 | RC0000012 | 0 Ω , $\frac{1}{4}W$ |
| RE44 | 1 | 1 | RC0000012 | 0 Ω , $\frac{1}{4}W$ |
| RE45 | 1 | 1 | RT0522514 | 2.2M Ω |
| RE46 | 1 | 1 | RT0522514 | 2.2M Ω |
| RE47 | 1 | 1 | RT0522514 | 2.2M Ω |
| RE48 | 1 | 1 | RT0522514 | 2.2M Ω |
| RE49 | 1 | 1 | RT0522514 | 2.2M Ω |
| RE50 | 1 | 1 | RT0522514 | 2.2M Ω |
| RE51 | 1 | 1 | RT0210314 | 10K Ω $\pm 2\%$, $\frac{1}{4}W$ |
| RE52 | 1 | 1 | RT0210314 | 10K Ω $\pm 2\%$, $\frac{1}{4}W$ |
| RE53 | 1 | 1 | RT0210314 | 10K Ω $\pm 2\%$, $\frac{1}{4}W$ |
| RE54 | 1 | 1 | RT0210314 | 10K Ω $\pm 2\%$, $\frac{1}{4}W$ |
| RE55 | 1 | 1 | RT0210314 | 10K Ω $\pm 2\%$, $\frac{1}{4}W$ |
| RE56 | 1 | 1 | RT0210314 | 10K Ω $\pm 2\%$, $\frac{1}{4}W$ |
| RE57 | 1 | 1 | RC0000012 | 0 Ω , $\frac{1}{4}W$ |
| RE58 | 1 | 1 | RC0000012 | 0 Ω , $\frac{1}{4}W$ |
| RE59 | 1 | 1 | RC0000012 | 0 Ω , $\frac{1}{4}W$ |
| RE60 | 1 | 1 | RC0000012 | 0 Ω , $\frac{1}{4}W$ |
| RE61 | 1 | 1 | RT0527214 | 2.7K Ω |

| REF. DESIG. | U | E | PART NO. | DESCRIPTION |
|---------------------------|---|---|-----------|---|
| RE62 | 1 | 1 | RT0510414 | 100K Ω |
| RE63 | 1 | 1 | RT0547414 | 470K Ω |
| RE64 | 1 | 1 | RT0547414 | 470K Ω |
| RE65 | 1 | 1 | RT0547314 | 47K Ω |
| RE66 | 1 | 1 | RT0547314 | 47K Ω |
| RE67 | 1 | 1 | RT0522114 | 220 Ω |
| RE68 | 1 | 1 | RT0522114 | 220 Ω |
| RE69 | 1 | 1 | RT0510314 | 10K Ω |
| RE70 | 1 | 1 | RT0510314 | 10K Ω |
| RE71 | 1 | 1 | RT0522414 | 220K Ω |
| RE72 | 1 | 1 | RT0522414 | 220K Ω |
| RE73 | 1 | 1 | RT0510114 | 100 Ω |
| RE74 | 1 | 1 | RC0000012 | 0 Ω , $\frac{1}{4}W$ |
| PE01-CAPACITORS | | | | |
| CE01 | 1 | 1 | DK1668101 | Ceramic, 680 $\mu F \pm 10\%$, 50V |
| CE02 | 1 | 1 | DK1668101 | Ceramic, 680 $\mu F \pm 10\%$, 50V |
| CE03 | 1 | 1 | DF1610405 | Film, 0.1PF $\pm 10\%$, 50V |
| CE04 | 1 | 1 | DF1610405 | Film, 0.1PF $\pm 10\%$, 50V |
| CE05 | 1 | 1 | DF1710552 | Film, 1 $\mu F \pm 20\%$, 250V |
| CE06 | 1 | 1 | DF1710552 | Film, 1 $\mu F \pm 20\%$, 250V |
| CE07 | 1 | 1 | DD1530001 | Ceramic, 30PF $\pm 5\%$, 50V |
| CE08 | 1 | 1 | DD1530001 | Ceramic, 30PF $\pm 5\%$, 50V |
| CE09 | 1 | 1 | EA1070109 | Electroly, 100 $\mu F \pm 50\%$, -10%, 10V |
| CE10 | 1 | 1 | EA1070109 | Electroly, 100 $\mu F \pm 50\%$, -10%, 10V |
| CE11 | 1 | 1 | EA1060359 | Electroly, 10 $\mu F \pm 50\%$, -10%, 35V |
| CE12 | 1 | 1 | EA1060359 | Electroly, 10 $\mu F \pm 50\%$, -10%, 35V |
| CE13 | 1 | 1 | EV3350356 | Electroly, 3.3 $\mu F \pm 20\%$, 35V |
| CE14 | 1 | 1 | EV3350356 | Electroly, 3.3 $\mu F \pm 20\%$, 35V |
| CE15 | 1 | 1 | DF1510305 | Film, 0.01 $\mu F \pm 5\%$, 50V |
| CE16 | 1 | 1 | DF1510305 | Film, 0.01 $\mu F \pm 5\%$, 50V |
| CE17 | 1 | 1 | DF1510305 | Film, 0.01 $\mu F \pm 5\%$, 50V |
| CE18 | 1 | 1 | DF1510305 | Film, 0.01 $\mu F \pm 5\%$, 50V |
| CE19 | 1 | 1 | DF1510305 | Film, 0.01 $\mu F \pm 5\%$, 50V |
| CE20 | 1 | 1 | DF1510305 | Film, 0.01 $\mu F \pm 5\%$, 50V |
| CE21 | 1 | 1 | DF1510305 | Film, 0.01 $\mu F \pm 5\%$, 50V |
| CE22 | 1 | 1 | DF1510305 | Film, 0.01 $\mu F \pm 5\%$, 50V |
| CE23 | 1 | 1 | DF1668205 | Film, 0.068 $\mu F \pm 5\%$, 50V |
| CE24 | 1 | 1 | DF1668205 | Film, 0.068 $\mu F \pm 5\%$, 50V |
| CE25 | 1 | 1 | DK1668101 | Ceramic, 680PF $\pm 10\%$, 50V |
| CE26 | 1 | 1 | DK1668101 | Ceramic, 680PF $\pm 10\%$, 50V |
| CE27 | 1 | 1 | DK1668101 | Ceramic, 680PF $\pm 10\%$, 50V |
| CE28 | 1 | 1 | DK1668101 | Ceramic, 680PF $\pm 10\%$, 50V |
| CE29 | 1 | 1 | DE1633205 | Film, 0.0033 $\mu F \pm 10\%$, 50V |
| CE30 | 1 | 1 | DF1633205 | Film, 0.0033 $\mu F \pm 10\%$, 50V |
| CE31 | 1 | 1 | DD1650001 | Ceramic, 50PF $\pm 10\%$, 50V |
| CE32 | 1 | 1 | DD1650001 | Ceramic, 50PF $\pm 10\%$, 50V |
| CE33 | 1 | 1 | EV1050256 | Electroly, 1 $\mu F \pm 20\%$, 25V |
| CE34 | 1 | 1 | EV1050256 | Electroly, 1 $\mu F \pm 20\%$, 25V |
| CE35 | 1 | 1 | EV3350356 | Electroly, 3.3 $\mu F \pm 20\%$, 25V |
| CE36 | 1 | 1 | EV3350356 | Electroly, 3.3 $\mu F \pm 20\%$, 25V |
| CE37 | 1 | 1 | EQ4750161 | Electroly, 4.7 $\mu F \pm 30\%$, 16V |
| CE38 | 1 | 1 | EQ4750161 | Electroly, 4.7 $\mu F \pm 30\%$, 16V |
| CE39 | 1 | 1 | EA2270359 | Electroly, 220 $\mu F \pm 50\%$, -10%, 35V |
| PE01-MISCELLANEOUS | | | | |
| HE01 | 1 | 1 | HC1000121 | IC, BA312 |
| HE02 | 1 | 1 | HC1000121 | IC, BA312 |
| HE03 | 1 | 1 | HT313272A | Transistor, 2SC1327 S. T |
| HE04 | 1 | 1 | HT107212A | Transistor, 2SA721 S. T |
| HE05 | 1 | 1 | HT313272A | Transistor, 2SC1327 S. T |
| HE06 | 1 | 1 | HT107212A | Transistor, 2SA721 S. T |

U U.S.A.
E Europe

| REF. DESIG. | U | E | PART NO. | DESCRIPTION |
|--|---|---|-----------|---------------------------------------|
| JE01 | 1 | 1 | YP0600026 | Plug, 14P |
| SE01 | 1 | 1 | SR1005007 | Rotary Switch, Tone Mode |
| BUFFER AMP. CIRCUIT BOARD-PH01 | | | | |
| PH01 | 1 | 1 | YD2918003 | P. W. Board, Buffer Amp. (Print Only) |
| | 1 | 1 | ZZ2918003 | P. W. Board Assembly |
| PH01-RESISTORS | | | | |
| All resistors are $\pm 5\%$ and $\frac{1}{4}W$. | | | | |
| RH01 | 1 | 1 | RT0562214 | 6.2K Ω |
| RH02 | 1 | 1 | RT0568214 | 6.8K Ω |
| RH03 | 1 | 1 | RT0512414 | 120K Ω |
| RH04 | 1 | 1 | RT0512414 | 120K Ω |
| RH05 | 1 | 1 | RT0512414 | 120K Ω |
| RH06 | 1 | 1 | RT0512414 | 120K Ω |
| RH07 | 1 | 1 | RN0518514 | 1.8M Ω |
| RH08 | 1 | 1 | RN0518514 | 1.8M Ω |
| RH09 | 1 | 1 | RN0518514 | 1.8M Ω |
| RH10 | 1 | 1 | RN0518514 | 1.8M Ω |
| RH11 | 1 | 1 | RN0515314 | 15K Ω |
| RH12 | 1 | 1 | RN0515314 | 15K Ω |
| RH13 | 1 | 1 | RN0515314 | 15K Ω |
| RH14 | 1 | 1 | RN0515314 | 15K Ω |
| RH15 | 1 | 1 | RT0575014 | 75 Ω |
| RH16 | 1 | 1 | RT0575014 | 75 Ω |
| RH17 | 1 | 1 | RT0547214 | 4.7K Ω |
| RH18 | 1 | 1 | RT0547214 | 4.7K Ω |
| RH19 | 1 | 1 | RT0536314 | 36K Ω |
| RH20 | 1 | 1 | RT0522414 | 220K Ω |
| RH21 | 1 | 1 | RT0522414 | 220K Ω |
| RH22 | 1 | 1 | RT0522414 | 220K Ω |
| RH23 | 1 | 1 | RT0522414 | 220K Ω |
| RH24 | 1 | 1 | RT0575014 | 75 Ω |
| RH25 | 1 | 1 | RT0575014 | 75 Ω |
| RH26 | 1 | 1 | RT0575014 | 75 Ω |
| RH27 | 1 | 1 | RT0575014 | 75 Ω |
| RH28 | 1 | 1 | RT0510114 | 100 Ω |
| PF01-CAPACITORS | | | | |
| CH01 | 1 | 1 | DF1722405 | Film, 0.22 $\mu F \pm 20\%$, 50V |
| CH02 | 1 | 1 | DF1722405 | Film, 0.22 $\mu F \pm 20\%$, 50V |
| CH03 | 1 | 1 | DF1722405 | Film, 0.22 $\mu F \pm 20\%$, 50V |
| CH04 | 1 | 1 | DF1722405 | Film, 0.22 $\mu F \pm 20\%$, 50V |
| CH05 | 1 | 1 | EV4750356 | Electroly, 4.7 $\mu F \pm 20\%$, 35V |
| CH06 | 1 | 1 | EV4750356 | Electroly, 4.7 $\mu F \pm 20\%$, 35V |
| CH07 | 1 | 1 | EV4750356 | Electroly, 4.7 $\mu F \pm 20\%$, 35V |
| CH08 | 1 | 1 | EV4750356 | Electroly, 4.7 $\mu F \pm 20\%$, 35V |
| CH09 | 1 | 1 | DK1750201 | Ceramic, 5000PF $\pm 20\%$, 50V |
| CH10 | 1 | 1 | DK1750201 | Ceramic, 5000PF $\pm 20\%$, 50V |
| CH11 | 1 | 1 | DK1750201 | Ceramic, 5000PF $\pm 20\%$, 50V |
| CH12 | 1 | 1 | DK1750201 | Ceramic, 5000PF $\pm 20\%$, 50V |
| CH13 | 1 | 1 | EA2270359 | Electroly, 220 μF , 35V |
| PE01-SEMICONDUCTORS & PLUGS | | | | |
| HH01 | 1 | 1 | HT313452A | Transistor, 2SC1345 D, E |
| HH02 | 1 | 1 | HT313452A | Transistor, 2SC1345 D, E |
| HH03 | 1 | 1 | HT313452A | Transistor, 2SC1345 D, E |
| HH04 | 1 | 1 | HT313452A | Transistor, 2SC1345 D, E |
| HH05 | 1 | 1 | HT107202A | Transistor, 2SC720 R, S |
| HH06 | 1 | 1 | HT107202A | Transistor, 2SC720 R, S |
| HH07 | 1 | 1 | HT107202A | Transistor, 2SC720 R, S |
| HH08 | 1 | 1 | HT107202A | Transistor, 2SC720 R, S |

| REF. DESIG. | U | E | PART NO. | DESCRIPTION |
|--|---|---|-----------|---|
| HH09 | 1 | 1 | HT313182Q | Transistor, 2SC1318 Q, R |
| HH10 | 1 | 1 | HT313182Q | Transistor, 2SC1318 Q, R |
| HH11 | 1 | 1 | HV0000606 | Varistor, VD1222 |
| JH01 | 1 | 1 | YP1000113 | Plug |
| JH10 | 1 | 1 | | |
| DOLBY TONE & METER CIRCUIT BOARD - PL01 | | | | |
| PL01 | 1 | 1 | YD2886009 | P. W. Board, Dolby, Tone & Meter (Print Only) |
| | 1 | 1 | ZZ2918109 | P. W. Board Assembly |
| PL01-RESISTORS | | | | |
| All resistors are $\pm 5\%$ and $\frac{1}{4}W$, unless otherwise indicated. | | | | |
| RL01 | 1 | 1 | RT0533214 | 3.3K Ω |
| RL02 | 1 | 1 | RT0547314 | 47K Ω |
| RL03 | 1 | 1 | RT0510114 | 100 Ω |
| RL04 | 1 | 1 | RT0533214 | 3.3K Ω |
| RL05 | 1 | 1 | RT0510214 | 1K Ω |
| RL06 | 1 | 1 | RT0512314 | 12K Ω |
| RL07 | 1 | 1 | RT0547314 | 47K Ω |
| RL08 | 1 | 1 | RC1010212 | 1K $\Omega \pm 10\%$, $\frac{1}{2}W$ |
| RL09 | 1 | 1 | RT0547214 | 4.7K Ω |
| RL10 | 1 | 1 | RT0510214 | 1K Ω |
| RL11 | 1 | 1 | RA0501012 | Trimming, 500 Ω (B) |
| RL12 | 1 | 1 | RA0502019 | Trimming, 5K Ω (B) |
| RL13 | 1 | 1 | RT0556314 | 56K Ω |
| RL14 | 1 | 1 | RT0556314 | 56K Ω |
| RL15 | 1 | 1 | RT0547214 | 4.7K Ω |
| RL16 | 1 | 1 | RT0533314 | 33K Ω |
| RL20 | 1 | 1 | RT0568414 | 680K Ω |
| RL21 | 1 | 1 | RT0568414 | 680K Ω |
| RL22 | 1 | 1 | RT0533414 | 330K Ω |
| RL23 | 1 | 1 | RT0533414 | 330K Ω |
| RL24 | 1 | 1 | RT0533214 | 3.3K Ω |
| RL25 | 1 | 1 | RT0533214 | 3.3K Ω |
| RL26 | 1 | 1 | RT0515214 | 1.5K Ω |
| RL27 | 1 | 1 | RT0515214 | 1.5K Ω |
| RL28 | 1 | 1 | RA0152004 | Trimming, 1.5K Ω (B) |
| RL29 | 1 | 1 | RA0152004 | Trimming, 1.5K Ω (B) |
| PL01-CAPACITORS | | | | |
| CL01 | 1 | 1 | DF1515305 | Film, 0.015 $\mu F \pm 5\%$ |
| CL02 | 1 | 1 | DF1515305 | Film, 0.015 $\mu F \pm 5\%$ |
| CL03 | 1 | 1 | DF1668301 | Film, 0.068 $\mu F \pm 10\%$ |
| CL04 | 1 | 1 | DF1610401 | Film, 0.1 $\mu F \pm 10\%$ |
| CL05 | 1 | 1 | EA1060169 | Electroly, 10 μF , 16V |
| CL06 | 1 | 1 | EA1060169 | Electroly, 10 μF , 16V |
| CL07 | 1 | 1 | EA1060169 | Electroly, 10 μF , 16V |
| CL10 | 1 | 1 | EA1060169 | Electroly, 10 μF , 16V |
| CL11 | 1 | 1 | EA1060169 | Electroly, 10 μF , 16V |
| CL12 | 1 | 1 | EA1060169 | Electroly, 10 μF , 16V |
| CL13 | 1 | 1 | EA1060169 | Electroly, 10 μF , 16V |
| CL14 | 1 | 1 | EA3360359 | Electroly, 33 μF , 35V |
| PL01-SEMICONDUCTORS & PLUGS | | | | |
| HL01 | 1 | 1 | HT307331C | Transistor, 2SC733 GR |
| HL02 | 1 | 1 | HT307331C | Transistor, 2SC733 GR |
| HL03 | 1 | 1 | HT307331C | Transistor, 2SC733 GR |
| HL06 | 1 | 1 | HT307331C | Transistor, 2SC733 GR |
| HL07 | 1 | 1 | HT307331C | Transistor, 2SC733 GR |
| HL08 | 1 | 1 | HD1000105 | Diode, IN60 |

| REF. DESIG. | U | E | PART NO. | DESCRIPTION |
|---------------------------------|---|---|-----------|---|
| HL09 | 1 | 1 | HD1000105 | Diode, IN60 |
| HL10 | 1 | 1 | HD1000105 | Diode, IN60 |
| HL11 | 1 | 1 | HD1000105 | Diode, IN60 |
| PL01 ? PL09 | 1 | 1 | YP1000113 | Plug |
| GENERAL MISCELLANEOUS | | | | |
| 0803 | 1 | 1 | 291816050 | Bracket K |
| 0811 | 2 | 2 | 51100306A | B. H. M. Screw B3 x 6 |
| 0813 | 2 | 2 | 51100306A | B. H. M. Screw B3 x 6 |
| 0814 | 2 | 2 | 51100306A | B. H. M. Screw B3 x 6 |
| 0815 | 2 | 2 | 51100306A | B. H. M. Screw B3 x 6 |
| 0819 | 2 | 2 | 51100306A | B. H. M. Screw B3 x 6 |
| 0824 | 2 | 2 | 51100306A | B. H. M. Screw B3 x 6 |
| 0828 | 3 | 3 | 51570305B | P. H. Tapt Screw P3 x 5 ST |
| 0832 | 2 | 2 | 51570305B | P. H. Tapt Screw P3 x 5 ST |
| 0908 | 2 | 2 | 291612001 | Insulator |
| 0911 | 1 | 1 | 289212201 | Sticker |
| 0916 | 1 | 1 | 291812002 | Insulator |
| 1034 | 2 | 2 | 51042608A | F. H. M. Screw F2.6 x 8 |
| 1111 | 2 | 2 | 51570306B | P. H. Tapt Screw P3 x 6 ST |
| 1112 | 2 | 2 | 54050300R | T. L. Washer OR |
| 1115 | 2 | 2 | 288610701 | Sheet |
| 1203 | 1 | 1 | 290416007 | Bracket |
| 1204 | 1 | 1 | 290416008 | Bracket |
| 1205 | 6 | 6 | 51100406A | B. H. M. Screw B4 x 6 |
| 1211 | 1 | 1 | 289226251 | Pulley K |
| 1216 | 2 | 2 | 51100306A | B. H. M. Screw B3 x 6 |
| 1311 | 1 | 1 | 257710602 | Bearing |
| 1312 | 1 | 1 | 141511801 | Spacer |
| 1313 | 2 | 2 | 51040306A | F. H. M. Screw F3 x 6 |
| 1320 | 2 | 2 | 51470306A | B. H. M. Screw S |
| 1410 | 2 | 2 | 287105302 | Cover |
| M001 | 1 | 1 | IM1104213 | DC Meter, Multipath, FM Tuning |
| M002 | 1 | 1 | IM1104209 | DC Meter, Dolby Level, Signal |
| C010 | 1 | 1 | EA3360109 | Electroly Cap., 33μF, 10V |
| C011 | 1 | 1 | EA3360109 | Electroly Cap., 33μF, 10V |
| J019 | 1 | 1 | YJ0600061 | Jack, 14P |
| 1003 | 1 | 1 | 289227401 | Reflector |
| 1005 | 1 | 1 | 289227101 | Holder |
| 1006 | 2 | 2 | 51570306B | P. H. Tapt Screw P3 x 6 ST |
| 1007 | 2 | 2 | 59030805P | Washer |
| 1009 | 1 | 1 | 289227102 | Holder |
| 1010 | 2 | 2 | 51570306B | P. H. Tapt Screw P3 x 6 ST |
| 1012 | 2 | 2 | 51480306A | B. H. M. Screw F |
| 1013 | 2 | 2 | 51100304A | B. H. M. Screw B3 x 4 |
| FUNCTION LAMP BOARD-PY01 | | | | |
| PY01 | 1 | 1 | YD2918008 | P. W. Board, Function Lamp (Print Only) |
| | | 1 | ZZ2918008 | P. W. Board Assembly |
| PY01-MISCELLANEOUS | | | | |
| MY01 ? MY08 | 1 | 1 | IN1008037 | Lamp, 8V, 40mA |

| REF. DESIG. | U | E | PART NO. | DESCRIPTION |
|---|---|---|-----------|--|
| JY01 ? JY12 | 1 | 1 | YP1000113 | Plug |
| DIAL LAMP BOARD-PZ01 | | | | |
| PZ01 | 1 | 1 | YD2892001 | P. W. Board, Dial Lamp (Print Only) |
| | 1 | 1 | ZZ2918201 | P. W. Board Assembly |
| PZ01-MISCELLANEOUS | | | | |
| MZ01 ? MZ06 | 1 | 1 | IN1008007 | Lamp |
| JZ01 ? JZ10 JZ11 ? JZ15 JZ17 ? JZ19 | 1 | 1 | YJ0800017 | Socket |
| | 1 | 1 | YP1000113 | Plug |
| M004 | 1 | 1 | IN1008007 | Lamp, Meter Lamp |
| M005 | 1 | 1 | IN1008007 | Lamp, Meter Lamp |
| J028 | 1 | 1 | YJ0800019 | Socket Meter Lamp |
| J029 | 1 | 1 | YJ0800019 | Socket Meter Lamp |
| 1103 | 1 | 1 | 288627401 | Reflector |
| 1106 | 1 | 1 | 288627102 | Holder |
| 1107 | 2 | 2 | 51570306B | P. H. Tapt Screw P3 x 6 ST |
| 1109 | 2 | 2 | 51480306A | B. H. M. Screw F. |
| S004 | 1 | 1 | SP0201009 | Pushswitch, Meter L/R |
| J007 | 1 | 1 | YJ0100098 | Jack, Dubbing Out |
| J008 | 1 | 1 | YJ0100081 | Jack, Dubbing In |
| 0827 | 1 | 1 | 291816005 | Bracket |
| R005 | 1 | 1 | RK0504010 | Variable Resist., 500KΩ (B) |
| R006 | 1 | 1 | RK0504010 | Variable Resist., 500KΩ (B) |
| R007 | 1 | 1 | RK0504010 | Variable Resist., 500KΩ (B) |
| R008 | 1 | 1 | RK0504010 | Variable Resist., 500KΩ (B) |
| 0818 | 1 | 1 | 289216003 | Bracket |
| DOLBY TONE, TAPE MON. BOARD-PS01 | | | | |
| PS01 | 1 | 1 | YD2918005 | P. W. Board, Dolby Tone/Tape Mon. (Print Only) |
| | 1 | 1 | ZZ2918005 | P. W. Board Assembly |
| SWITCH BOARD-PT01 | | | | |
| PT01 | 1 | 1 | YD2918006 | P. W. Board, Switch (Print Only) |
| | 1 | 1 | ZZ2918006 | P. W. Board Assembly |
| PT01-MISCELLANEOUS | | | | |
| ST01 | 1 | 1 | SP0603011 | Pushswitch |
| JT01 ? JT25 | 1 | 1 | YP1000113 | Plug |

U U.S.A.
E Europe

| REF. DESIG. | U | E | PART NO. | DESCRIPTION |
|-------------|---|---|-----------|---|
| R001 | 1 | 1 | RS0503020 | Variable Resist., 50KΩ (MN) <i>GM</i> |
| PU01 | 1 | 1 | YD2918007 | MULTIPATH, HI BLEND CIRCUIT BOARD-PU01 P. W. Board, Multipath/Hi Blend (Print Only) |
| | 1 | 1 | ZZ2918007 | P. W. Board Assembly |
| SU01 | 1 | 1 | SP0408001 | PU01-SWITCH Pushswitch |
| | | | | PU01-RESISTORS All resistors are ±5% and ¼W, unless otherwise indicated. |
| RU01 | 1 | 1 | GD0520314 | 20KΩ |
| RU02 | 1 | 1 | GD0522214 | 2.2KΩ |
| RU03 | 1 | 1 | GD0522214 | 2.2KΩ |
| RU04 | 1 | 1 | GD0510314 | 10KΩ |
| RU05 | 1 | 1 | RT0556214 | 5.6KΩ |
| RU06 | 1 | 1 | RT0510214 | 1KΩ |
| RU07 | 1 | 1 | GD0510414 | 100KΩ |
| RU08 | 1 | 1 | RT0547414 | 470KΩ |
| RU09 | 1 | 1 | RT0547414 | 470KΩ |
| RU10 | 1 | 1 | RT0512314 | 12KΩ |
| RU11 | 1 | 1 | RT0512314 | 12KΩ |
| RU12 | 1 | 1 | RT0512314 | 12KΩ |
| RU13 | 1 | 1 | RT0512314 | 12KΩ |
| RU14 | 1 | 1 | RT0522514 | 2.2MΩ |
| RU15 | 1 | 1 | RT0522514 | 2.2MΩ |
| RU16 | 1 | 1 | RT0518514 | 1.8MΩ |
| RU17 | 1 | 1 | RT0518514 | 1.8MΩ |
| RU18 | 1 | 1 | RN0518514 | 1.8MΩ |
| RU19 | 1 | 1 | RN0518514 | 1.8MΩ |
| RU20 | 1 | 1 | GD0543314 | 43KΩ |
| RU21 | 1 | 1 | GD0510414 | 100KΩ |
| RU22 | 1 | 1 | GD0522314 | 22KΩ |
| RU23 | 1 | 1 | GD0522314 | 22KΩ |
| RU24 | 1 | 1 | GD0547214 | 4.7KΩ |
| RU25 | 1 | 1 | GD0547214 | 4.7KΩ |
| RU26 | 1 | 1 | GD0522414 | 220KΩ |
| RU27 | 1 | 1 | GD0522414 | 220KΩ |
| RU28 | 1 | 1 | GD0522114 | 220Ω |
| RU29 | 1 | 1 | GD0522114 | 220Ω |
| RU30 | 1 | 1 | RT0516214 | 1.6KΩ |
| RU31 | 1 | 1 | RT0513214 | 1.3KΩ |
| RU32 | 1 | 1 | GQ1033103 | 330Ω ± 10%, 3W |
| RU33 | 1 | 1 | GQ1033103 | 330Ω ± 10%, 3W |
| RU34 | 1 | 1 | GJ0515101 | 150Ω ± 5%, 1W |
| RU35 | 1 | 1 | GJ0515101 | 150Ω ± 5%, 1W |
| | | | | PU01-CAPACITORS |
| CU01 | 1 | 1 | EA4750359 | Electroly, 4.7μF, 35V |
| CU02 | 1 | 1 | EA4750359 | Electroly, 4.7μF, 35V |
| CU03 | 1 | 1 | EA1060169 | Electroly, 10μF, 16V |
| CU04 | 1 | 1 | EA4750359 | Electroly, 4.7μF, 35V |
| CU05 | 1 | 1 | DF1622305 | Film, 2200PF±5%, 50V |
| CU06 | 1 | 1 | DF1547205 | Film, 4700PF±5%, 50V |
| CU07 | 1 | 1 | DF1547205 | Film, 4700PF±5%, 50V |
| CU08 | 1 | 1 | DF1547205 | Film, 4700PF±5%, 50V |
| CU09 | 1 | 1 | DF1547205 | Film, 4700PF±5%, 50V |
| CU10 | 1 | 1 | DF1522205 | Film, 2200PF±5%, 50V |
| CU11 | 1 | 1 | DF1522205 | Film, 2200PF±5%, 50V |
| CU12 | 1 | 1 | DF1510205 | Film, 1000PF±5%, 50V |

| REF. DESIG. | U | E | PART NO. | DESCRIPTION |
|-------------|---|---|-----------|--|
| CU13 | 1 | 1 | DF1510205 | Film, 1000PF ± 5%, 50V |
| CU14 | 1 | 1 | DF1722405 | Film, 0.22μF ± 20%, 50V |
| CU15 | 1 | 1 | DF1722405 | Film, 0.22μF ± 20%, 50V |
| CU16 | 1 | 1 | EV4750356 | Electroly, 4.7μF, 35V |
| CU17 | 1 | 1 | EV4750356 | Electroly, 4.7μF, 35V |
| CU18 | 1 | 1 | DK1750201 | Ceramic, 5000PF, 50V |
| CU19 | 1 | 1 | DK1750201 | Ceramic, 5000PF, 50V |
| CU20 | 1 | 1 | EA4760359 | Electroly, 47μF, 35V |
| CU21 | 1 | 1 | EA1060169 | Electroly, 10μF, 16V |
| | | | | PU01-SEMICONDUCTORS & PLUGS |
| HU01 | 1 | 1 | HT308282A | Transistor, 2SC828R,S |
| HU02 | 1 | 1 | HT308282A | Transistor, 2SC828R,S |
| HU03 | 1 | 1 | HD1000105 | Diode, IN60 |
| HU04 | 1 | 1 | HD1000105 | Diode, IN60 |
| HU05 | 1 | 1 | HT313272A | Transistor, 2SC1327S,T |
| HU06 | 1 | 1 | HT313272A | Transistor, 2SC1327S,T |
| HU07 | 1 | 1 | HT107223A | Transistor, 2SA722S,T,U |
| HU08 | 1 | 1 | HT107223A | Transistor, 2SA722S,T,U |
| JU01 | ? | 1 | YP1000113 | Plug |
| JU21 | | | | |
| | | | | GENERAL MISCELLANEOUS |
| S005 | 1 | 1 | SP0101017 | Pushswitch, Power Supply |
| 0822 | 1 | 1 | 290416006 | Bracket |
| 0823 | 2 | 2 | 51100306A | B. H. M. Screw B3 x 6 |
| J009 | 1 | 1 | YJ0100098 | Jack, Phone |
| 0831 | 1 | 1 | 291816006 | Bracket |
| 2306 | 1 | 1 | 62030039W | Lug |
| 1016 | 1 | 1 | 289205101 | Guide |
| 1018 | 1 | 1 | 289226252 | Pulley K |
| 1025 | 1 | 1 | 289226253 | Pulley K |
| 1032 | 4 | 4 | 51570305B | P. H. Tapt Screw P3 x 6ST |
| 1316 | 1 | 1 | 285310650 | Bearing K |
| 1326 | 1 | 1 | 51640412D | Set Screw C.P. |
| 1327 | 1 | 1 | 54040402N | Spring Washer |
| 1328 | 1 | 1 | 53110403E | Hexagon Nut |
| 0503 | 1 | | 291816001 | Bracket |
| 0505 | | 1 | 291816022 | Bracket |
| 0511 | 1 | | 145525903 | Bush |
| 0513 | 4 | 4 | 51100308S | B. H. M. Screw B3 x 8 |
| 0514 | 4 | 4 | 53110303A | Hexagon Nut |
| 0515 | 4 | 4 | 54050300R | T. L. Washer OR |
| 0526 | 1 | | 282125901 | Bush |
| 0527 | 2 | | 53110303A | Hexagon Nut |
| 0528 | 2 | | 54050300R | T. L. Washer OR |
| 0529 | 2 | | 51060316A | P. H. M. Screw P3 x 16 |
| 0530 | 2 | | 55060305S | T. R. Rivet |
| 0532 | 1 | | 284906702 | Cap |
| 0603 | 4 | 4 | 51100306S | B. H. M. Screw B3 x 6 |
| 0604 | 4 | 4 | 53110303A | Hexagon Nut |
| 0606 | 2 | 2 | 51100306S | B. H. M. Screw B3 x 6 |
| 0609 | 8 | 8 | 51100306S | B. H. M. Screw B3 x 6 |
| 0610 | 8 | 8 | 53110303A | Hexagon Nut |
| 0613 | 3 | 3 | 53228059E | Nut |
| 0619 | 1 | 1 | 54050400R | T. L. Washer OR |
| 0720 | 3 | 3 | 51100306S | B. H. M. Screw B3 x 6 |
| 0722 | 1 | 1 | 145525903 | Bush |

| REF. DESIG. | U | E | PART NO. | DESCRIPTION |
|-------------|---|---|-----------|---|
| J002 | 1 | 1 | YT0101003 | Terminal, Ground |
| J003 | 1 | 1 | YT0204008 | Terminal, Phono/Aux, 4P |
| J004 | 1 | 1 | YT0208006 | Terminal, Tape In, Out, 8P |
| J006 | 1 | 1 | YT0201009 | Terminal, Quadradial, 1P |
| J010 | 1 | 1 | YT0304008 | Terminal, Main Spk |
| J011 | 1 | 1 | YT0304008 | Terminal, Remote Spk |
| J012 | 1 | 1 | YJ0400048 | Plug, AC Outlet |
| J013 | 1 | 1 | YJ0400048 | Plug, AC Outlet |
| J014 | 1 | 1 | YJ0800012 | Socket, Fuse Holder |
| W002 | 1 | 1 | YC0240010 | AC Cord |
| F001 | 1 | 1 | FS1080004 | Fuse, 8A UL |
| G001 | 1 | 1 | BF1040003 | Printed Compo. |
| R014 | 1 | 1 | RA0203007 | Variable Resist., 20KΩ (B) |
| L001 | 1 | 1 | LF1120038 | Ant. Coil, AM |
| 0705 | 1 | 1 | 257816052 | Bracket K |
| 0710 | 1 | 1 | 281927103 | Holder |
| 0712 | 2 | 2 | 51100308S | B. H. M. Screw B3 x 8 |
| 0713 | 2 | 2 | 53110303E | Hexagon Nut |
| 0716 | 2 | 2 | 51100310S | B. H. M. Screw B3 x 10 |
| 0717 | 2 | 2 | 53110303E | Hexagon Nut |
| PV01 | 1 | 1 | YD2918009 | ANTENNA TERMINAL BOARD-PV01 P. W. Board, Antenna Terminal (Print Only) |
| | 1 | 1 | ZZ2918009 | P. W. Board Assembly |
| LV01 | 1 | 1 | LB3007526 | PV01-MISCELLANEOUS Balun Coil 300Ω-75Ω |
| LV02 | 1 | 1 | LC1154002 | Choke Coil |
| JV01 | 1 | 1 | YP1000113 | Plug |
| JV02 | 1 | 1 | YP1000113 | Plug |
| JV03 | 1 | 1 | YP1000113 | Plug |
| J001 | 1 | 1 | YT0304007 | Terminal, AM/FM Ant. |
| 0607 | 1 | 1 | 291616005 | Bracket |
| PC01 | 1 | 1 | YD2892011 | FM CAL.& DE-EMPHASIS CIRCUIT BOARD-PC01 P. W. Board, FM Cal.& FM De-Emphasis (Print Only) |
| | 1 | 1 | ZZ2918111 | P. W. Board Assembly |
| RC01 | 1 | 1 | RT0515414 | PC01-RESISTORS & PLUGS Resistor, 150KΩ ± 5%, ¼W |
| RC02 | 1 | 1 | RT0515414 | Resistor, 150KΩ ± 5%, ¼W |
| RC03 | 1 | 1 | RT0582214 | Resistor, 8.2KΩ ± 5%, ¼W |
| RC04 | 1 | 1 | RT0582214 | Resistor, 8.2KΩ ± 5%, ¼W |
| RC05 | 1 | 1 | RK0203030 | Variable Resist., 20KΩ(B) |
| RC06 | 1 | 1 | RK0203030 | Variable Resist., 20KΩ(B) |
| JC01 | 1 | 1 | YP1000113 | Plug |
| JC02 | 1 | 1 | YP1000113 | Plug |
| JC03 | 1 | 1 | YP1000113 | Plug |
| JC04 | 1 | 1 | YP1000113 | Plug |
| JC05 | 1 | 1 | YP1000113 | Plug |
| JC06 | 1 | 1 | YP1000113 | Plug |

| REF. DESIG. | U | E | PART NO. | DESCRIPTION |
|-------------|---|---|-----------|---|
| C002 | 1 | 1 | DK1710301 | GENERAL MISCELLANEOUS Ceramic Cap., 0.01μF ± 20%, 50V |
| C003 | 1 | 1 | DK1710301 | Ceramic Cap., 0.01μF ± 20%, 50V |
| C004 | 1 | 1 | DK1710301 | Ceramic Cap., 0.01μF ± 20%, 50V |
| 0620 | 1 | 1 | 62041760W | Lug |
| R009 | 1 | 1 | RC1022512 | Resistor, 2.2MΩ ± 10%, ¼W |
| 2322 | 1 | 1 | 62030039W | Lug |
| C015 | 1 | 1 | DK1710301 | Ceramic Cap., 0.01μF ± 20%, 50V |
| J005 | 1 | 1 | YT0204009 | Terminal, Pre Out/Main In |
| 2325 | 1 | 1 | 62030039W | Lug |
| 1403 | 1 | 1 | 291830201 | Dial |
| 1408 | 1 | 1 | 289210701 | Sheet |
| S001 | 1 | 1 | SR1006015 | Rotary Switch, Selector |
| S002 | 1 | 1 | SR2505002 | Rotary Switch, Dolby |
| R012 | 1 | 1 | RT0539214 | Resistor, 3.9KΩ ± 5%, ¼W |
| C013 | 1 | 1 | DF1522205 | Film Cap., 2200PF ± 5%, 50V |
| C013 | 1 | 1 | DF1510205 | Film Cap., 1000PF ± 5%, 50V |
| S003 | 1 | 1 | SR0405007 | Rotary Switch, Mode |
| R002 | 1 | 1 | RT0510214 | Resistor, 1KΩ ± 5%, ¼W |
| R003 | 1 | 1 | RT0510214 | Resistor, 1KΩ ± 5%, ¼W |
| R004 | 1 | 1 | RT0515114 | Resistor, 150Ω ± 5%, ¼W |
| C014 | 1 | 1 | DF1522205 | Film Cap., 2200PF ± 5%, 50V |
| C014 | 1 | 1 | DF1510205 | Film Cap., 1000PF ± 5%, 50V |
| 1718 | 1 | 1 | 291726703 | Heat Sink |
| 1722 | 4 | 4 | 51100310B | B. H. M. Screw B3 x 10 |
| 1723 | 4 | 4 | 54040302N | Spring Washer |
| 1724 | 4 | 4 | 53110301E | Hexagon Nut |
| H009 | 1 | 1 | HD20Q1608 | Rectifier, SG-5TS |
| H010 | 1 | 1 | HD20Q1708 | Rectifier, SG-5TR |
| C006 | 1 | 1 | DF1710453 | Film Cap., 0.1μF ± 20%, 250V |
| C007 | 1 | 1 | DF1710453 | Film Cap., 0.1μF ± 20%, 250V |
| L003 | 1 | 1 | LC1332002 | Choke Coil, 3.3μH |
| C005 | 1 | 1 | DK1710301 | Ceramic Cap., 0.01μF ± 20%, 50V |
| J016 | 1 | 1 | YL0105011 | Plug, 5P (UL) |
| R010 | 1 | 1 | GJ0522203 | Resistor, 2.2KΩ ± 5%, 3W |
| R011 | 1 | 1 | GJ0522203 | Resistor, 2.2KΩ ± 5%, 3W |
| J015 | 1 | 1 | YL0105011 | Plug, 5P (UL) |
| 2008 | 1 | 1 | 291810905 | Shield |
| 2010 | 1 | 1 | 291812001 | Insulator |
| 2123 | 1 | 1 | 289216012 | Bracket |
| 2125 | 1 | 1 | 62030039W | Lug |
| R013 | 1 | 1 | RA0503014 | Variable Resist., 50KΩ (B) |
| W012 | 1 | 1 | YB0007001 | Connective Cord |
| W013 | 1 | 1 | YB0007001 | Connective Cord |
| J031 | 1 | 1 | YL0106004 | Terminal, Voltage Conversion |

U U.S.A.
E Europe

| REF. DESIG. | U | E | PART NO. | DESCRIPTION |
|------------------------------|---|----|-----------|--------------------------------|
| 2210 | | 1 | 289216006 | Bracket |
| 2211 | | 1 | 285412001 | Insulator |
| 2212 | | 2 | 51100310E | B. H. M. Screw B3 x 10 |
| 2213 | | 5 | 54060300R | T. L. Washer IR |
| FUSE BOARD-PR01 | | | | |
| PR01 | | 1 | YD2892010 | P. W. Board, Fuse (Print Only) |
| | | 1 | ZZ2892810 | P. W. Board Assembly |
| PR01-MISCELLANEOUS | | | | |
| FR01 | | 1 | FS1060002 | Fuse, 6A |
| FR02 | | 1 | FS1015003 | Fuse, 1.5A |
| FR03 | | 1 | FS1015003 | Fuse, 1.5A |
| FR03 | | 1 | FS1020005 | Fuse, 2A |
| JR01 | | 1 | YJ0800020 | Jack |
| JR02 | | 1 | YJ0800020 | Jack |
| JR03 | | 1 | YJ0800020 | Jack |
| JR04 | | 1 | YJ0800020 | Jack |
| JR05 | | 1 | YJ0800020 | Jack |
| JR06 | | 1 | YJ0800020 | Jack |
| JR07 | | 1 | YJ0800020 | Jack |
| JR08 | | 1 | YJ0800020 | Jack |
| JR09 | | 1 | YP1000099 | Plug |
| JR10 | | 1 | YP1000099 | Plug |
| JR11 | | 1 | YP1000099 | Plug |
| JR12 | | 1 | YP1000099 | Plug |
| JR13 | | 1 | YP1000099 | Plug |
| JR14 | | 1 | YP1000099 | Plug |
| JR15 | | 1 | YP1000099 | Plug |
| JR16 | | 1 | YP1000099 | Plug |
| GENERAL MISCELLANEOUS | | | | |
| 2525 | | 1 | 138200503 | Clamper |
| 2234 | | 1 | 138200503 | Clamper |
| 2232 | | 1 | 138200503 | Clamper |
| 0903 | | 1 | 291810907 | Shield |
| 0904 | | 1 | 288912005 | Insulator |
| 0906 | | 2 | 291812004 | Insulator |
| 0221 | | 4 | 275905701 | Leg |
| 0222 | | 4 | 51490410S | B. H. M. Screw F. S. |
| 0733 | | 8 | 51100306S | B. H. M. Screw B3 x 6 |
| 0905 | | 4 | 51100304A | B. H. M. Screw B3 x 4 |
| 0913 | | 1 | 261105501 | Collor |
| 1207 | | 14 | 51570306B | P. H. Tapt Screw P3 x 6 |
| 1503 | | 1 | 291810550 | Chassis K |
| 1512 | | 2 | 289225901 | Bush |
| 1603 | | 4 | 51490614A | B. H. M. Screw F. S. |
| 1604 | | 4 | 53110601A | Hexagon Nut |
| 1605 | | 4 | 54020801A | Flat Washer P |
| 1616 | | 4 | 515704088 | P. H. Tapt Screw P4 x 8 ST |
| 1618 | | 1 | 291816004 | Bracket |
| 1620 | | 2 | 51100508E | B. H. M. Screw B5 x 8 |
| 1621 | | 2 | 54020501E | Flat Washer P |
| 1622 | | 2 | 54040502N | Spring Washer |
| 1624 | | 2 | 51570408B | P. H. Tapt Screw P4 x 8 ST |
| 1625 | | 2 | 54050400R | T. L. Washer OR |
| 1631 | | 2 | 51100508E | B. H. M. Screw B5 x 8 |
| 1632 | | 2 | 54040502N | Spring Washer |
| 1711 | | 4 | 51100306S | B. H. M. Screw B3 x 6 |
| 1720 | | 2 | 51570308B | P. H. Tapt Screw P3 x 8 ST |
| 1920 | | 8 | 51570306B | P. H. Tapt Screw P3 x 6 ST |
| 1926 | | 1 | 291810901 | Shield |

| REF. DESIG. | U | E | PART NO. | DESCRIPTION | |
|-------------|---|---|----------|--------------------------------------|---|
| 1927 | | 4 | 4 | 51570306B P. H. Tapt Screw P3 x 6 ST | |
| 2003 | | 4 | 4 | 288810102 Support | |
| 2009 | | 2 | 2 | 51570306B P. H. Tapt Screw P3 x 6 ST | |
| 2013 | | 4 | 4 | 288810102 Support | |
| 2029 | | 2 | 2 | 51570306B P. H. Tapt Screw P3 x 6 ST | |
| 2103 | | 4 | 4 | 285610102 Support | |
| 2104 | | 1 | 1 | 281810107 Support | |
| 2107 | | 1 | 1 | 285610902 Shield | |
| 2108 | | 5 | 5 | 51100304E B. H. M. Screw B3 x 4 | |
| 2113 | | 4 | 4 | 51100306S B. H. M. Screw B3 x 6 | |
| 2117 | | 2 | 2 | 288605501 Collor | |
| 2118 | | 2 | 2 | 51100310S B. H. M. Screw B3 x 10 | |
| 2124 | | 2 | 2 | 51570305B P. H. Tapt Screw P3 x 5 ST | |
| 2131 | | 2 | 2 | 288616011 Bracket | |
| 2132 | | 2 | 2 | 288612009 Insulator | |
| 2133 | | 4 | 4 | 51570306B P. H. Tapt Screw P3 x 6 ST | |
| 2203 | | 2 | 2 | 51100306S B. H. M. Screw B3 x 6 | |
| 2214 | | | 2 | 53110503A Hexagon Nut | |
| 2215 | | | 2 | 54040502N Spring Washer | |
| 2216 | | | 1 | 289212006 Insulator | |
| 2217 | | | 2 | 51100312S B. H. M. Screw B3 x 12 | |
| 2221 | | | 1 | 285416003 Bracket | |
| 2222 | | | 2 | 51570306B P. H. Tapt Screw P3 x 6 ST | |
| 2223 | | | 2 | 51100306S B. H. M. Screw | |
| 2229 | | | 2 | 291811802 Spacer | |
| 2235 | | | 1 | 53110503A Hexagon Nut | |
| 2327 | | | 1 | 138200503 Clamper | |
| 2328 | | | 1 | 51570306B P. H. Tapt Screw P3 x 6 ST | |
| 2329 | | | 1 | 54050300R T. L. Washer OR | |
| 2303 | | | 2 | 281805603 Buffer | |
| 2307 | | | 1 | 51570306B P. H. Tapt Screw P3 x 6 ST | |
| 2309 | | | 1 | 138200503 Clamper | |
| 2310 | | | 1 | 51570306B P. H. Tapt Screw P3 x 6 ST | |
| 2311 | | | 1 | 54050300R T. L. Washer OR | |
| 2313 | | | 2 | 51570306B P. H. Tapt Screw P3 x 6 ST | |
| 2314 | | | 2 | 54050300R T. L. Washer OR | |
| 2316 | | | 1 | 51570306B P. H. Tapt Screw P3 x 6 ST | |
| 2317 | | | 1 | 54050300R T. L. Washer OR | |
| 2319 | | | 1 | 51570306B P. H. Tapt Screw P3 x 6 ST | |
| 2320 | | | 1 | 54050300R T. L. Washer OR | |
| 2323 | | | 1 | 51570306B P. H. Tapt Screw P3 x 6 ST | |
| 2326 | | | 1 | 51570306B P. H. Tapt Screw P3 x 6 ST | |
| 2331 | | | 1 | 288600505 Clamper | |
| 2332 | | | 2 | 288600506 Clamper | |
| 2334 | | | 2 | 288600505 Clamper | |
| 2518 | | | 4 | 4 | 51570306B P. H. Tapt Screw P3 x 6 ST |
| L004 | | | 1 | TS6330207 Transformer | |
| L004 | | | 1 | TS6330208 Transformer | |
| C008 | | | 1 | 1 | EC1590701 Electroly Cap., 15μF + 50%, -10%, 70V |
| C009 | | | 1 | 1 | EC1590701 Electroly Cap., 15μF + 50%, -10%, 70V |
| J017 | | | 1 | 1 | YJ0600062 Jack |
| J018 | | | 1 | 1 | YJ0600063 Jack |
| 0113 | | | 3 | 3 | 289610701 Sheet |
| 0116 | | | 4 | 4 | 52017039J Bolt |
| 0118 | | | 1 | 1 | 291605501 Collor |
| 0119 | | | 1 | 1 | 289205502 Collor |
| 0120 | | | 1 | 1 | 51340308P F. H. Tap Screw |
| 0207 | | | 4 | 4 | 51480406S B. H. M. Screw F |
| 0208 | | | 4 | 4 | 51122605S T. H. M. Screw T2.6 x 5 |
| 0217 | | | 12 | 12 | 51100406S B. H. M. Screw B4 x 6 |
| 0303 | | | 1 | 1 | 290415404 Knob, Power Switch |

U U.S.A.
E Europe

| REF. DESIG. | U | E | PART NO. | DESCRIPTION |
|-------------|----|----|-----------|----------------------------------|
| 0304 | 1 | 1 | 285015401 | Knob, Slide Volume |
| 0305 | 4 | 4 | 288615401 | Knob, Dolby Level |
| 0306 | 12 | 12 | 288615403 | Knob, Pushswitch |
| 0308 | 5 | 5 | 281815403 | Knob, 24φ |
| 0403 | 1 | | 291826501 | Indicator |
| 0405 | 1 | 1 | 291826503 | Indicator |
| 0412 | 2 | 2 | 51100305S | B. H. M. Screw B3 x 5 |
| 0416 | 1 | 1 | 257886101 | Label, UL Caution |
| 0417 | 1 | 1 | 257886102 | Label, Do not remove cover. |
| 0418 | 1 | 1 | 257886103 | Label, See marking on bottom. |
| 0419 | 1 | 1 | 250626506 | Indicator, Do not use as handle. |
| 0423 | 1 | | 951110102 | Label, UL |
| 0424 | 1 | | 951091102 | Label, UL Factory Cord No. |
| 0434 | 1 | 1 | 288686102 | Label, Dolby |
| 0435 | 1 | 1 | 288686101 | Label, Marantz |
| 1323 | 1 | 1 | 285011202 | Shaft |
| 1324 | 1 | 1 | 54040402N | Spring Washer |
| 1414 | 1 | 1 | 287311802 | Spacer |
| 1417 | 1 | 1 | 289226902 | Protector |
| 1418 | 2 | 2 | 51570306B | P. H. Tapt Screw P3 x 6 ST |
| 1421 | 1 | 1 | 291826901 | Protector |
| 1422 | 2 | 2 | 51570306B | P. H. Tapt Screw P3 x 6 ST |
| 1425 | 1 | 1 | 281912005 | Insulator |
| 1431 | 1 | 1 | 289226901 | Protector |
| 1432 | 2 | 2 | 51100304S | B. H. M. Screw B3 x 4 |
| 2005 | 1 | 1 | 288910904 | Shield |
| 2006 | 4 | 4 | 51100304S | B. H. M. Screw B3 x 4 |
| 2015 | 1 | 1 | 291810906 | Shield |
| 2016 | 4 | 4 | 51100306S | B. H. M. Screw B3 x 6 |
| 2031 | 1 | 1 | 288610902 | Shield |
| 2032 | 2 | 2 | 51100304S | B. H. M. Screw B3 x 4 |
| 2033 | 2 | 2 | 51570306B | P. H. Tapt Screw P3 x 6 ST |
| 2521 | 1 | 1 | 289010903 | Shield |
| 2522 | 4 | 4 | 289205601 | Buffer |
| 2523 | 2 | 2 | 51100304S | B. H. M. Screw B3 x 4 |
| 2614 | 1 | 1 | 56382540G | Eyelet |
| 2903 | 1 | 1 | 257785401 | Guarantee Card |
| 2906 | 1 | 1 | 257785102 | Instructions |
| 2908 | 1 | | 257781301 | Envelope |
| 2909 | 1 | | 281881301 | Envelope |
| 2926 | 1 | 1 | ZA0200007 | Ext. Antenna, FM |
| 3003 | 1 | 1 | 291880101 | Packing Case, Inner |
| 3004 | 1 | 1 | 291880111 | Packing Case, Outer |
| 3012 | 1 | 1 | 289280301 | Partitioner, Upper |
| 3013 | 1 | 1 | 289280302 | Partitioner, Lower |
| 3018 | 1 | 1 | 901534543 | Polyethylen Bag, Set |
| 3020 | 1 | 1 | 901302501 | Polyethylen Bag, Printed Matter |
| 3021 | 1 | 1 | 901302501 | Polyethylen Bag, Accessories |
| 3023 | 1 | 1 | 102980401 | Sleeve |
| 3024 | 1 | 1 | 281905601 | Buffer |
| 3025 | 2 | 2 | 273182101 | Silicagel |
| 3026 | 1 | | 956000004 | Hang Tag |
| 3029 | 4 | | 952281501 | Serial NO Card |
| 3031 | 4 | | 952301511 | Serial NO Card |
| 2803 | 1 | | 291885101 | Instructions, Set |
| 2804 | 1 | | 291885122 | Instructions, Set |
| 2811 | 1 | | 291885601 | Schematic Diagram |
| 2813 | 1 | | 291885603 | Schematic Diagram |
| 2817 | 1 | | 281885108 | Instructions, Accessories |
| 2821 | 1 | 1 | 281885110 | Instructions, 4-CH |
| 2823 | 1 | 1 | 281885104 | Instructions, Packing |

TECHNICAL SPECIFICATIONS

PREAMPLIFIER SECTION

| | |
|---|--|
| Dynamic Range | Phono input: 100dB above 1.5 μ V equivalent noise input |
| Note: Dynamic Range is the ratio in dB of phono overload (110mV) to equivalent input noise (1.5 μ V). | |
| Input Sensitivity and Impedance | Phono: 1.8 mV, 47K ohms High Level: 180 mV, 100K ohms |
| Output Level and Impedance | Tape Recorder: 1V into 47K ohms |
| Pre-Out Output Impedance | 1V, 900 ohms |
| Phono Frequency Response | 30Hz to 15kHz \pm 1dB (RIAA) |
| Noise-Aux | -80dB |
| Tone Controls | Treble: \pm 10dB at 15kHz Bass: \pm 10dB at 50Hz Mid-Range: \pm 5dB at 700Hz |
| Filters | Hi Filter: 9kHz, 12dB per octave Low Filter: 50Hz, 12dB per octave |
| Loudness Compensation | 7dB at 100Hz 4dB at 10kHz |

AMPLIFIER SECTION

| | |
|--|---|
| Headphones Output | 0.7V into 8 ohms at rated distortion |
| Input Sensitivity for MAIN IN | 1V |
| Rated Power Output (Continuous average power per channel, all channels driven) | |
| Power Output | 125 Watts, 4 ohms 125 Watts, 8 ohms 75 Watts, 16 ohms |
| Power Band | 20Hz to 20kHz |
| THD | 0.15% |
| Frequency Response | \pm 2dB, 5Hz to 70kHz \pm 1dB, 10Hz to 30kHz |
| Damping Factor | 40 at 1kHz |

FM SECTION

| | |
|---------------------------|--|
| Quieting Slope | 1.9 μ V for 30dB, 5 μ V for 55dB 10 μ V for 60dB, 50 μ V for 70dB |
| Ultimate Quieting | 50 μ V for 70dB |
| Selectivity | Alternate channel, better than 75dB |
| Capture Ratio | 1.5dB |
| Muting Threshold | Muting threshold variable from 8 μ V to 40 μ V |
| Stereo Separation | 42dB at 1kHz, 27dB at 15kHz |
| Total Harmonic Distortion | Stereo: Less than 0.3% Mono: Less than 0.2% |
| Frequency Response | \pm 1dB, 30Hz to 15kHz |
| Total Spurious Rejection | Better than 90dB |
| Image Rejection | Better than 90dB |
| AM Suppression | Better than 60dB |
| IF Rejection | Better than 100dB |
| Antenna Impedance | 300 ohm Balanced, 75 ohm unbalanced |
| Quadrantal Output | 300 mV, 15K ohms for \pm 75kHz Deviation |

AM SECTION

| | |
|----------------|------------------------|
| AM Sensitivity | Better than 40 μ V |
|----------------|------------------------|

Selectivity Adjacent channel, 1000kHz, better than 30dB
AM Bandwidth (-6dB) 7kHz
Image Rejection 1400kHz, better than 70dB

GENERAL

Power Requirements 220V~50/60Hz
(This unit can be converted by a qualified technician to operate 110/120/240V~50/60Hz)
Unit Dimensions Height: 5-3/8" (without feet)
Dimensions — Panel Width 19-5/16"-490mm
 — Panel Height 5-3/4"-146mm
 — Depth 15-3/16"-386mm
Weight — Unit alone 49.5lbs-22.5Kg
 — Packed for Shipment 57.2lbs-26.0Kg

* These specifications and exterior designs may be changed for improvement without advance notice.

SERVICE INFORMATION FOR EUROPEAN MODEL

The information contained here in included the rear panel and main chassis component locations, voltage conversion, FTZ regulation and schematic diagram.
For the circuit description, alignment method and repairing hints, refer to the original service manual.

TABLE OF CONTENTS

| | |
|---|----|
| Main Chassis Component Locations (Top View) | 45 |
| Voltage Conversion | 46 |
| Voltage Conversion Chart | 46 |
| FTZ Regulation | 46 |
| Schematic Diagram | 49 |

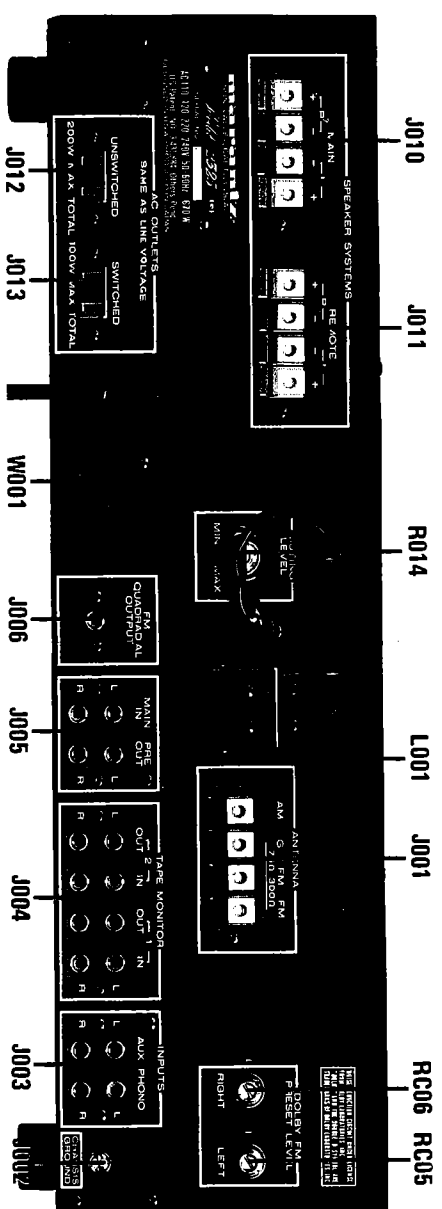

Figure 26. Rear Panel Adjustments and Component Locations

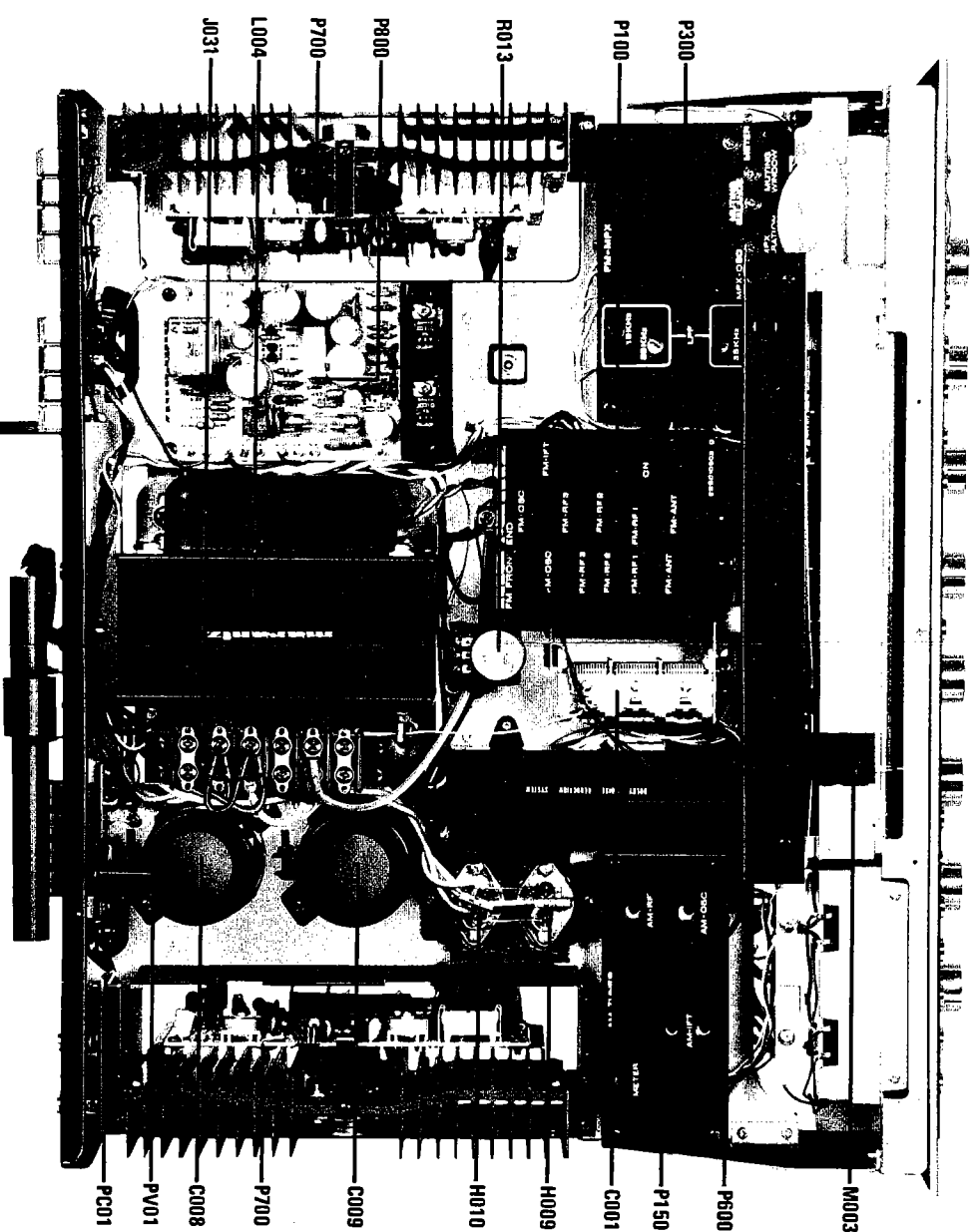

Figure 27. Main Chassis Component Locations (Top View)

VOLTAGE CONVERSION

This model is equipped with a universal power transformer to permit operation at 110, 120, 220 and 240 V AC 50 to 60 Hz.

To convert the unit to the required voltage perform the following steps:

- (1) Remove the lid (top).
- (2) Change the jumper wires as illustrated below for the required AC voltage.

NOTE

CAUTION: DISCONNECT POWER SUPPLY CORD FROM AC OUTLET BEFORE CONVERTING VOLTAGE.

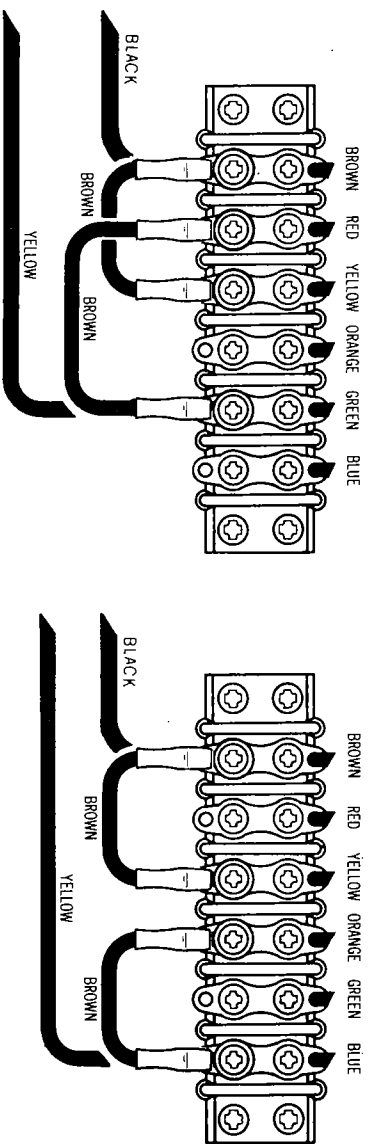

For 110V Operation

For 120V Operation

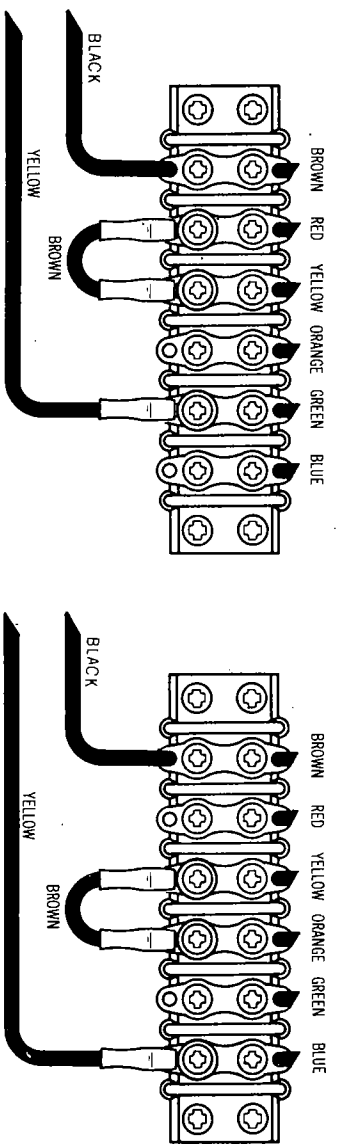

For 220V Operation

For 240V Operation

Figure 28. Voltage Conversion Chart

FTZ REGULATION

Instruction for the use in the range other than specified in FTZ codes

Achtung für die Leute, die in dem Gebiet wohnen, wo die FTZ-Bestimmungen vorherrschend sind.

Sollte das Gerät auch für Frequenzen ausserhalb des in den FTZ-Bestimmungen angegebene. Bereiches empfangebereit sein, bitten wir, den Bereich durch Nachstellen des Kernes in der Oszillatorschule (in der Abbildung mit "FTZ" gekennzeichnet) so zu korrigieren, dass er den Bestimmungen entspricht.

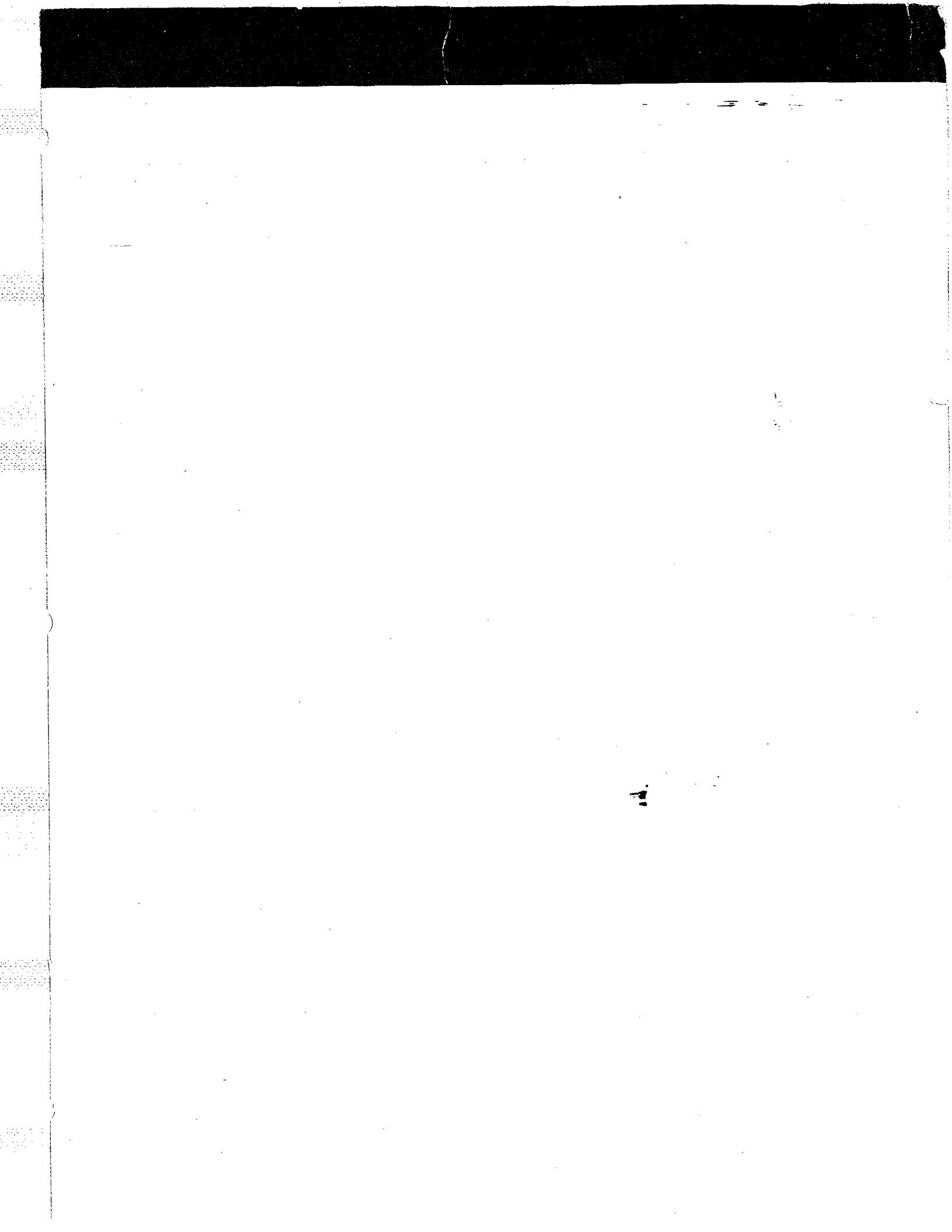



marantz

MARANTZ CO., INC. • P.O. BOX 99 • SUN VALLEY, CALIFORNIA • 91352



A WHOLLY-OWNED SUBSIDIARY OF SUPERSCOPE INC., SUN VALLEY, CALIFORNIA 91352

SQ is a trademark of CBS INC.
Noise reduction circuit under license from Dolby Laboratories, Inc.
"DOLBY" and the Double-D symbol are trademarks of Dolby Laboratories, Inc.